



**ROBERTO
BOTTEGHI**

accessori auto e carrozzeria

CATALOGO GENERALE 2024

8[^] EDIZIONE



Accessori Esterni

pag. 1 - 73

Ricambi Auto / Autocarri

pag. 74 - 78

Accessori Interni

pag. 79 - 85

Tappeti e Fodere

pag. 86 - 95

Schienali e Stuoie

pag. 96

Estate

pag. 97 - 100

Pulizia

pag. 101 - 102

Emergenza e Manutenzione

pag. 103 - 114

Elementi Elettrici

pag. 115 - 146

Profumazioni

pag. 147 - 149

Chimici e Lubrificanti

pag. 150 - 199

Neve

pag. 200 - 210



**ROBERTO
BOTTEGHI**
accessori auto e carrozzeria





OPUS

Art. GO 13/2
Art. GO 14/2
Art. GO 15/2
Art. GO 16/2



SILVERSTONE

Art. GO 13/4
Art. GO 14/4
Art. GO 15/4
Art. GO 16/4



GIGA

Art. GO 13/1
Art. GO 14/1
Art. GO 15/1
Art. GO 16/1



GIGA BLACK

Art. GO 13/1B
Art. GO 14/1B
Art. GO 15/1B
Art. GO 16/1B

Accessori Esterni



MEGA

Art. GO 13/5
Art. GO 14/5
Art. GO 15/5
Art. GO 16/5



RST BLACK

Art. GO 13/SB
Art. GO 14/SB
Art. GO 15/SB
Art. GO 16/SB





INTENSO PRO

Art. GO 13/IN
Art. GO 14/IN
Art. GO 15/IN
Art. GO 16/IN



INTENSO PRO BLACK

Art. GO 13/INB
Art. GO 14/INB
Art. GO 15/INB
Art. GO 16/INB



RACING

Art. GO13/3
Art. GO14/3
Art. GO15/3
Art. GO16/3



VOLTEC

Art. GO13VPRO
Art. GO14VPRO
Art. GO15VPRO
Art. GO16VPRO

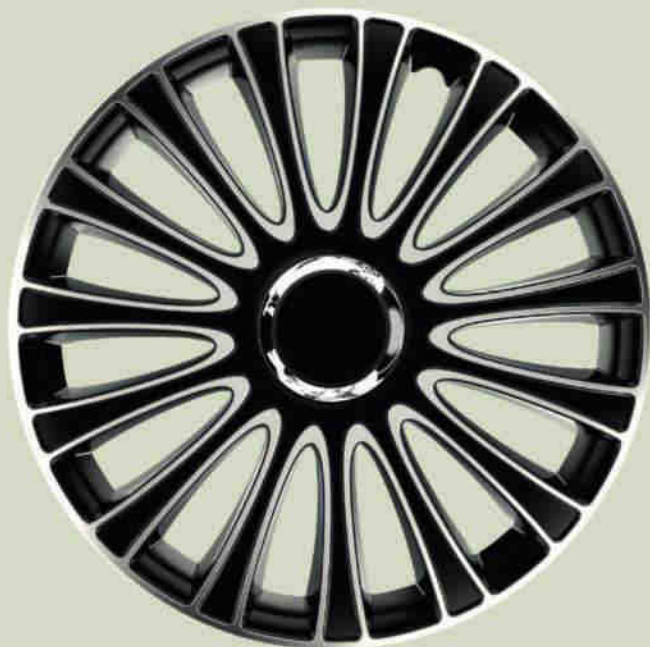

LE MANS PRO

Art. GO 13/7
Art. GO 14/7
Art. GO 15/7
Art. GO 16/7



MAGNUM PRO

Art. GO 14/MAG
Art. GO 15/MAG
Art. GO 16/MAG



PLATIN SILVER BLACK

Art. GO 14/PLA
Art. GO 15/PLA



GRIP PRO

Art. GO 14/GP
Art. GO 15/GP
Art. GO 16/GP



SPEED VAN

Art. GO 15/VAN
Art. GO 16/VAN



VR CARBON BLACK

Art. GO 13/VRB
Art. GO 14/VRB
Art. GO 15/VRB
Art. GO 16/VRB



RADICAL PRO BLACK

Art. GO 13/8D
Art. GO 14/8D
Art. GO 15/8D
Art. GO 16/8D



RADICAL PRO

Art. GO 13/8
Art. GO 14/8
Art. GO 15/8
Art. GO 16/8



FARAD



COPRICERCHI UNIVERSALI



UNIVERSAL WHEEL TRIMS



ENJOLIVEURS DE ROUE UNIVERSALES



UNIVERSAL RADKAPPEN



EMBELLECEDERES DE RUDA

SERIE 200

www.farad.it



Accessori Esterni

Part. nr. **201 Silver**
13" - 14"



Part. nr. **207 Silver**
13"



Part. nr. **212 Silver**
13" - 14" - 15" - 16"



Part. nr. **202 Silver**
13" - 14"



Part. nr. **208 Silver**
13" - 14"



Part. nr. **212 Chromed nuts**
13" - 14" - 15" - 16"



Part. nr. **204 Silver**
12" - 13" - 14" - 15" - 16"



Part. nr. **209 Silver**
13" - 14" - 15"



Part. nr. **213 Silver**
13"



Part. nr. **205 Silver**
13" - 14"



Part. nr. **210 Silver**
13" - 14" - 15"



Part. nr. **214 Silver**
12" - 13" - 14" - 15"



Part. nr. **206 Silver**
13" - 14" - 15"



Part. nr. **211 Silver**
13" - 14"



Part. nr. **216 Silver**
13" - 14" - 15"



SERIE
200

COPPOLICERCHI
UNIVERSALI

Accessori Esterni

Part. nr. **216 Chromed cap**
13" - 14" - 15"



Part. nr. **219C Chrome**
14"



Part. nr. **224 Silver**
13" - 14" - 15" - 16"



Part. nr. **217 Silver**
13" - 14"



Part. nr. **220 Silver**
13" - 14" - 15"



Part. nr. **225 Silver**
15"



Part. nr. **218 Silver**
13" - 14" - 15"



Part. nr. **221 Silver**
13"



Part. nr. **225 CHROME**
15"



Part. nr. **219 Silver**
13" - 14" - 15"



Part. nr. **222 Silver**
15"



Part. nr. **226 Silver**
13" - 14" - 15"



Part. nr. **219C Silver**
13" - 14" - 15"



Part. nr. **223 Silver**
13" - 14" - 15"



Part. nr. **227 Silver**
13" - 14" - 15"



SERIE
2000
COPPIE
UNIVERSALI

Accessori Esterni

Part. nr. **228 Silver**
13" - 14" - 15" - 16"



Part. nr. **233 Silver**
13" - 14" - 15" - 16" - 17"



Part. nr. **237 Silver**
14" - 15" - 16"



2000
SERIE

Part. nr. **229 Silver**
13" - 14" - 15"



Part. nr. **234**
13" - 14" - 15" - 16"



Part. nr. **238 Silver**
14" - 15" - 16"



COPPIGERSCH
UNIVERSAL

Part. nr. **230 Silver**
13" - 14" - 15" - 16"



Part. nr. **235**
14" - 15" - 16"



Part. nr. **239**
15"



Part. nr. **231 Silver**
16"



Part. nr. **235 Black**
15"



Part. nr. **404 Silver**
13" - 15"



Part. nr. **232 Silver**
13" - 14" - 15" - 16"



Part. nr. **236**
14" - 15" - 16"

- Universale (anche per furgoni)
- Universal (also for vans)
- Universel (aussi pour fourgons)
- Universal (auch für Lieferwagen)
- Universal (incluso para furgonetas)



FARAD

Accessori Esterni

COPPA UNIVERSALE 242

Art. 242 14" - 15" - 16"



GRIGIO



NERO
OPACO

FARAD
made in Italy



FARAD
mini-DEFLECTOR



Montaggio "Mini Deflectors"

Modello anteriore



 I deflettori d'aria FARAD "Mini Deflectors" sono facili da installare (è necessario soltanto l'ausilio degli utensili forniti) disponibili inoltre, per alcuni modelli di auto, una versione con fissaggio adesivo "With sticker". Non trascurabile la vasta gamma di applicazioni per i camion. Grazie alla loro forma aerodinamica e piacevole alla vista, appaiono come parte integrante dell'auto o dei veicoli commerciali.



Deflettori d'aria FARAD "Mini Deflectors"

Costruiti con materiale di ultima generazione antiurto ed antischegge, i deflettori d'aria FARAD costituiscono un accessorio fondamentale per tutte le auto. Importanti case automobilistiche utilizzano FARAD come fornitore ufficiale di questo articolo.

Tra le loro molteplici utilità possiamo evidenziare, oltre ad un chiaro abbellimento estetico dell'autovettura, le seguenti caratteristiche:

- possibilità di mantenere abbassato il finestrino con qualsiasi condizione climatica;
- ricircolo dell'aria in caso di pioggia o presenza di fumatori;
- consistente diminuzione del climatizzatore che è causa di svariati disturbi;
- risparmio energetico con conseguente recupero sui consumi che il climatizzatore sottrae al motore in funzione;
- riduzione del rumore causato dal passaggio dell'aria all'interno dell'abitacolo a finestrino aperto che cresce con l'aumento della velocità di crociera;
- stile di guida più confortevole e sicuro lontano da pericolose distrazioni, quali improvvisi ingressi di insetti o altri corpi estranei all'interno dell'autovettura.

Modello posteriore



spinelli[®]
the art of covering

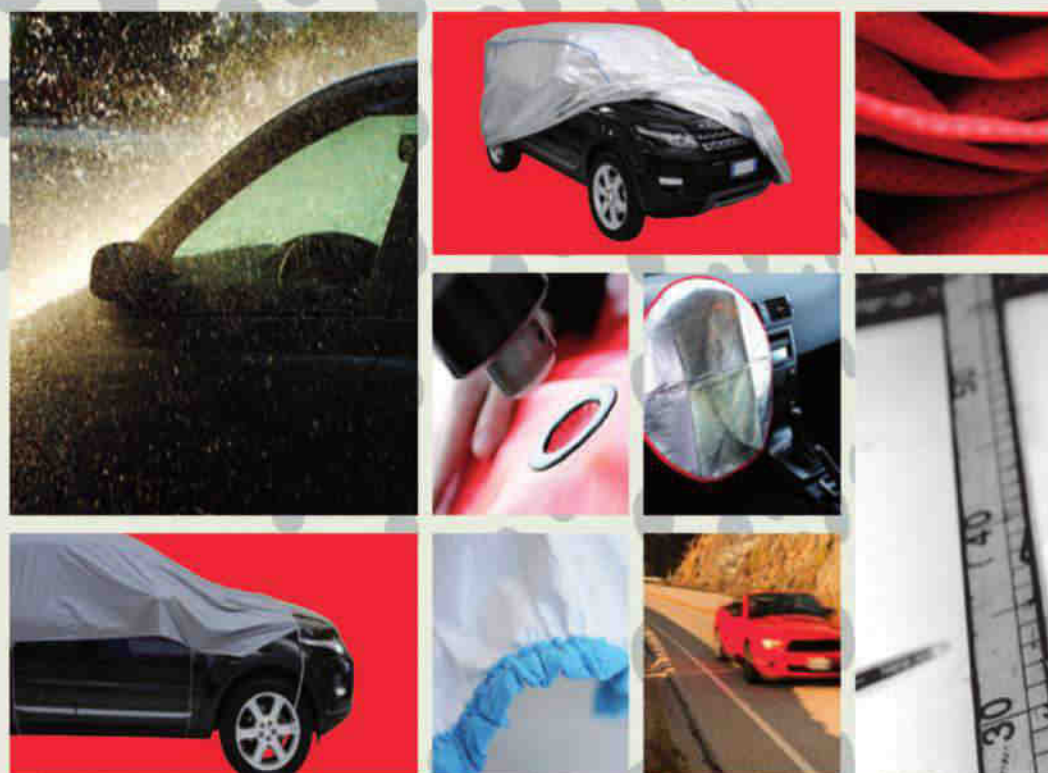

COPRIAUTO - COPRIMOTO **SPINELLI**

Per applicazioni consultare catalogo Spinelli
Copriauto - Coprimoto

Bogart®

Copriauto Car cover

CLASSIC LINE



**Tessuto
CALIFORNIA**



AREATORI



BORDI ELASTICI



MORBIDO TESSUTO
NON TESSUTO
INTERNO

Bogart Classic Line è la linea di copriauto outdoor che offre una protezione completa contro sole, pioggia, neve, ghiaccio e polvere. Una copertura pratica e resistente grazie alle sue caratteristiche:

impermeabile al 100%

rivestimento interno in un morbido tessuto non

tessuto per proteggere la vernice da graffi e abrasioni

ottima resistenza al calore: è possibile coprire la

macchina dopo pochi minuti dallo spegnimento del motore.



Bogart[®]

Copriauto Car cover

SUNCOVER LINE



Il copriauto Suncover è resistente all'acqua e traspirante. Il coating esterno riflette i raggi UV e riduce il surriscaldamento dell'abitacolo, del volante e dei sedili.

La morbida felpatura interna protegge la vernice della macchina. Montaggio facile con bordo anteriore e posteriore elasticizzato.

10 TAGLIE

COLORE: ARGENTO

Tessuto POLY

Con 10 taglie copri quasi tutto il parco macchine in circolazione.















COPRIAUTO in 10 MISURE

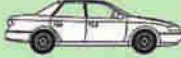
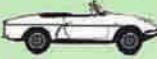

- riduce il vostro assortimento e stoccaggio
- di facile consultazione (vedi lista delle applicazioni + incrocia marca e modello con il materiale = misura corrispondente)
- 10 taglie = coperture per oltre il 90% del circolante (per le restanti vetture attenersi al catalogo standard)

Nota: riducendo le taglie a 10 per alcune vetture le coperture possono risultare abbondanti

MISURA size	MODELLI models	DIMENSIONI VETTURE IN METRI car dimensions in meters			MISURA size	MODELLI models	DIMENSIONI VETTURE IN METRI car dimensions in meters		
		LUNGHEZZA MASSIMA max length	LARGHEZZA MASSIMA max width	ALTEZZA MASSIMA max height			LUNGHEZZA MASSIMA max length	LARGHEZZA MASSIMA max width	ALTEZZA MASSIMA max height
A		3,82	1,63	1,46	F	 	4,82	1,80	1,44
B		3,85	1,68	1,60	G		4,88	1,76	1,48
C		4,10	1,72	1,45	H	 	4,15	1,72	1,70
D		4,35	1,76	1,60	N	 	4,65	1,80	1,65
E	 	4,52	1,76	1,45	P	 	4,85	1,95	1,85

* Si sconsiglia l'uso del copriauto Tyvek®TopCover su vetture cabrio con capote in tessuto







Taglie universali Bacall

RICERCA PER TIPOLOGIA MOTO



Lettura della tabella

Linee → **TOP LINE**

Taglia	Tipologia moto						Misure
S SS S1					4,70 m (S) 5,30 m (SS) 5,20 m (S1)	2,70 m (S) 2,95 m (SS) 3,30 m (S1)	

↑ Tipologia moto

TOP LINE

Taglia	Tipologia moto						
S SS S1 S2 S3 small						4,70 m (S) 5,30 m (SS) 5,20 m (S1)	2,70 m (S) 2,95 m (SS) 3,30 m (S1)
						5,20 m (S2) 4,70 m (S3)	3,80 m (S2) 3,80 m (S3)
M MS M1 M2 medium						5,70 m (M) 5,60 m (MS) 6,45 m (M1) 6,45 m (M2)	2,90 m (M) 3,10 m (MS) 3,40 m (M1) 3,90 m (M2)
							
L large						6,40 m	3,50 m
XL extra large						6,80 m	3,72 m
Sidecar							

Bacall®

Coprimoto

CLASSIC LINE

CALIFORNIA



La più venduta

Bacall Classic Line è la linea di coprimoto outdoor che offre una protezione completa contro sole, pioggia, neve, ghiaccio e polvere.

- 100% impermeabile
- Morbido tessuto non tessuto all'interno per proteggere la vernice da graffi e abrasioni
- Resistente al calore: è possibile coprire la moto dopo pochi minuti dallo spegnimento



























Bacall Classic Line California mantiene le stesse caratteristiche della copertura outdoor Garage, ma è più leggera. E' maneggevole e facile da mettere. Offre una protezione a 360 gradi per tutte le condizioni meteo - sole, pioggia, neve, ghiaccio - e contro l'inquinamento. E' da anni affermata sul mercato per il suo **eccellente rapporto qualità-prezzo.**

18 TAGLIE



Accessori Esterni

CLASSIC LINE

Taglia	Tipologia moto			
A°			4,20 m	2,74 m
A1			4,40 m	3,26 m
A3***		Modelli A B C c/parabrezza alto	4,60 m	3,70 m
B			4,40 m	2,70 m
B1***	 	Modelli A B C c/bauiletto	5,20 m	3,26 m
B2**		Mod. A B C c/bauiletto+parabrezza alto	5,20 m	3,70 m
C			3,80 m	2,74 m
D°	  		5,30 m	3,44 m
DS***			5,30 m	2,95 m
E°	  		5,60 m	3,44 m
ES***			5,60 m	3,10 m
E1*** E2*** E3*	  	E1=modelli D E c/bauiletto E2=mod. D E c/bauiletto+parabrezza alto	6,45 m 6,45 m 6,45 m	3,44 m 3,90 m 3,90 m
F			5,20 m	3,44 m
G	 		6,00 m	3,50 m
H***	 		6,80 m	3,72 m
Sidecar*				

Accessori Esterni

Coprimoto-scooter universale in poliestere antistrappo-antipioggia con bordo elasticizzato.

Coprimoto art. B0032 183x89x120 cm (Small)



8 008144 019393

Coprimoto art. B0033 203x89x120 cm (Medium)



8 008144 019409

Coprimoto art. B0034 228x99x124 cm (Large)



8 008144 019416

Coprimoto art. B0035 246x104x127 cm (XLarge)



8 008144 019423

Coprimoto "POCKET"
in poliestere rinforzato.

Conf. 1 pezzo in scatola

Coprimoto in pvc felpato internamente antistrappo-antipioggia con bordo elasticizzato

Coprimoto art. B0040 183x89x120 cm (Small)



8 008144 090408

Coprimoto art. B0041 203x89x120 cm (Medium)



8 008144 090415

Coprimoto art. B0042 228x99x124 cm (Large)



8 008144 090422

Coprimoto art. B0043 246x104x127 cm (XLarge)



8 008144 090439

Coprimoto "COVERCYCLE"
in P.V.C. felpato

Conf. 1 pezzo in borsa nylon



Super Cover

MOTO e SCOOTER

telo di protezione impermeabile e felpato

FELPATO



ARTICOLO	TAGLIA	MISURA (cm.)
C8600S	S	183x89x122
C8600M	M	203x89x122
C8600L	L	232x100x125
C8600XL	XL	246x105x140
C8600XXL	XXL	294x105x140

- Protegge da macchie di resina, polvere, calore e formazione di ghiaccio
- Pvc accoppiato felpato 250 gr.
- Sagomato per migliorare la vestibilità
- Felpato internamente

Accessori Esterni

Copriauto "Stingray" in pvc felpato internamente antistrappo.
Conf 1 pezzo in valigetta nylon



COPRIBICICLETTA ECOLINE
Colore grigio misura 200x100

Art. SPCMPE2

Copriauto art. B0199



lunghezza vettura
da 3,50 a 4,00 mt
(XSmall)

Copriauto art. B0200



lunghezza vettura
da 4,10 a 4,30 mt
(Small)

Copriauto art. B0201



lunghezza vettura
da 4,30 a 4,50 mt
(Medium)

Copriauto art. B0202



lunghezza vettura
da 4,50 a 4,80 mt
(Large)

Copriauto art. B0203



lunghezza vettura
da 4,80 a 5,30 mt
(XLarge)

Copriauto art. B0204



per vetture
monovolume
(Medium)

Copriauto art. B0205



per vetture
monovolume
(Large)



COPRIAUTO
STINGRAY

TABELLA APPLICAZIONE COPRIAUTO STINGRAY

MODELLO VETTURA	A4 8011						A4 8021						A4 8031					
	SMALL	SMALL	MEDIUM	LARGE	LARGE	LARGE	SMALL	SMALL	MEDIUM	LARGE	LARGE	LARGE	SMALL	SMALL	MEDIUM	LARGE	LARGE	LARGE
ALFA ROMEO																		
147																		
159																		
159 SPORTSWAGON																		
03																		
BREVA																		
SPIDER																		
AUDI																		
A3																		
A3 SPORTBACK																		
A4																		
A4 AVANT																		
A4 CABRIOLET																		
A6																		
A6 AVANT																		
A8																		
TT COUPE																		
R8																		
A6 ALLROAD																		
Q5																		
Q7																		
A																		
BMW																		
1																		
118 COUPE																		
118 CABRIO																		
120																		
120 COUPE																		
120 CABRIO																		
120i																		
120i COUPE																		
120i CABRIO																		
120i																		
120i COUPE																		
120i CABRIO																		
120i																		
120i COUPE																		
120i CABRIO																		
120i																		
120i COUPE																		
120i CABRIO																		
120i																		
120i COUPE																		
120i CABRIO																		
120i																		
120i COUPE																		
120i CABRIO																		
120i																		
120i COUPE																		
120i CABRIO																		
120i																		
120i COUPE																		
120i CABRIO																		
120i																		
120i COUPE																		
120i CABRIO																		
120i																		
120i COUPE																		
120i CABRIO																		
120i																		
120i COUPE																		
120i CABRIO																		
120i																		
120i COUPE																		
120i CABRIO																		
120i																		
120i COUPE																		
120i CABRIO																		
120i																		
120i COUPE																		
120i CABRIO																		
120i																		
120i COUPE																		
120i CABRIO																		
120i																		
120i COUPE																		
120i CABRIO																		
120i																		
120i COUPE																		
120i CABRIO																		
120i																		
120i COUPE																		
120i CABRIO																		
120i																		
120i COUPE																		
120i CABRIO																		
120i																		
120i COUPE																		
120i CABRIO																		
120i																		
120i COUPE																		
120i CABRIO																		
120i																		
120i COUPE																		
120i CABRIO																		
120i																		
120i COUPE																		
120i CABRIO																		
120i																		
120i COUPE																		
120i CABRIO																		
120i																		
120i COUPE																		
120i CABRIO																		
120i																		
120i COUPE																		
120i CABRIO																		
120i																		
120i COUPE																		
120i CABRIO																		
120i																		
120i COUPE																		
120i CABRIO																		
120i																		
120i COUPE																		
120i CABRIO																		
120i																		
120i COUPE																		
120i CABRIO																		
120i																		
120i COUPE																		
120i CABRIO																		
120i																		
120i COUPE																		
120i CABRIO																		
120i																		
120i COUPE																		
120i CABRIO																		
120i																		
120i COUPE																		

Accessori Esterni

Copriauto "Galaxy" in poliestere rinforzato.

Conf. 1 pezzo in scatola



Copriauto art. B0018 lunghezza vettura da 3,90 a 4,10 mt (Small)



8 008144 019430

Copriauto art. B0019 lunghezza vettura da 4,10 a 4,30 mt (Medium)



8 008144 019447

Copriauto art. B0020 lunghezza vettura da 4,30 a 4,80 mt (Large)



8 008144 019454

Copriauto art. B0021 lunghezza vettura da 4,80 a 5,30 mt (XLarge)



8 008144 019461



COPRISELLA IN GARAGE Colore Nero

Art.SPCSGA1/11 misura medium 90x60

Art.SPCSGA2/11 misura large 107x60

Art.SPCSGA3/11 misura X large 120x65

Super Cover

Auto e Suv

Telo di protezione Impermeabile e Felpato



- Protegge da macchie di resina, polvere, calore e formazione di ghiaccio
- Zip apertura lato guida
- Tasche per specchietti esterni retrovisori
- In materiale impermeabile PVC 250 gr
- Felpato internamente



SUV



ARTICOLO	TAGLIA	MISURA (cm.)
C8400S	S	385x168x145
C8400M	M	435x176x145
C8400L	L	488x176x145
C8400XL	XL	492x186x148
C8400XXL	XXL	540x192x148

ARTICOLO	TAGLIA	MISURA (cm.)
C8500S	S	460x176x165
C8500M	M	470x190x185
C8500L	L	485x195x185
C8500XL	XL	515x195x185

Accessori Esterni



Art. A0927



8 008144 010208
Nastro fermapacchi.
Conf. 2 pezzi in blister
2,5 mt

Art. A0928



8 008144 004825
Nastro fermapacchi
con cricchetto. Conf. 1
pezzo in blister
5 mt



Art. A0928/G



8 008144 021037
Nastro fermapacchi da 25 mm
con ganci e cricchetto rinforzato.
Conf. 2 pezzi
5 mt



Art. A0171

**Portatarga posteriore metallo
eruo targa '99**

Art. A0177/F

**Portatarga posteriore plastica
eruo targa '99**



Art. A0171/A

**Portatarga posteriore metallo
eruo targa '99**

Art. A0177/A

**Portatarga anteriore plastica
eruo targa '99**



Art. A0034



8 008144 012585
Corde elastiche fermapacchi.
Conf 2 pezzi in blister
100 cm

Art. A0035



8 008144 012592
Corde elastiche fermapacchi.
Conf 2 pezzi in blister
150 cm

K-FERRO



SPAZZOLE TERGICRISTALLO

METALLO CON PROFILO IN GOMMA

Art. KRKF250 - mm 250
Art. KRKF280 - mm 280
Art. KRKF330 - mm 330
Art. KRKF350 - mm 350
Art. KRKF400 - mm 400
Art. KRKF425 - mm 425
Art. KRKF450 - mm 450
Art. KRKF480 - mm 480

Art. KRKF500 - mm 500
Art. KRKF530 - mm 530
Art. KRKF550 - mm 550
Art. KRKF575 - mm 575
Art. KRKF600 - mm 600
Art. KRKF650 - mm 650
Art. KRKF700 - mm 700

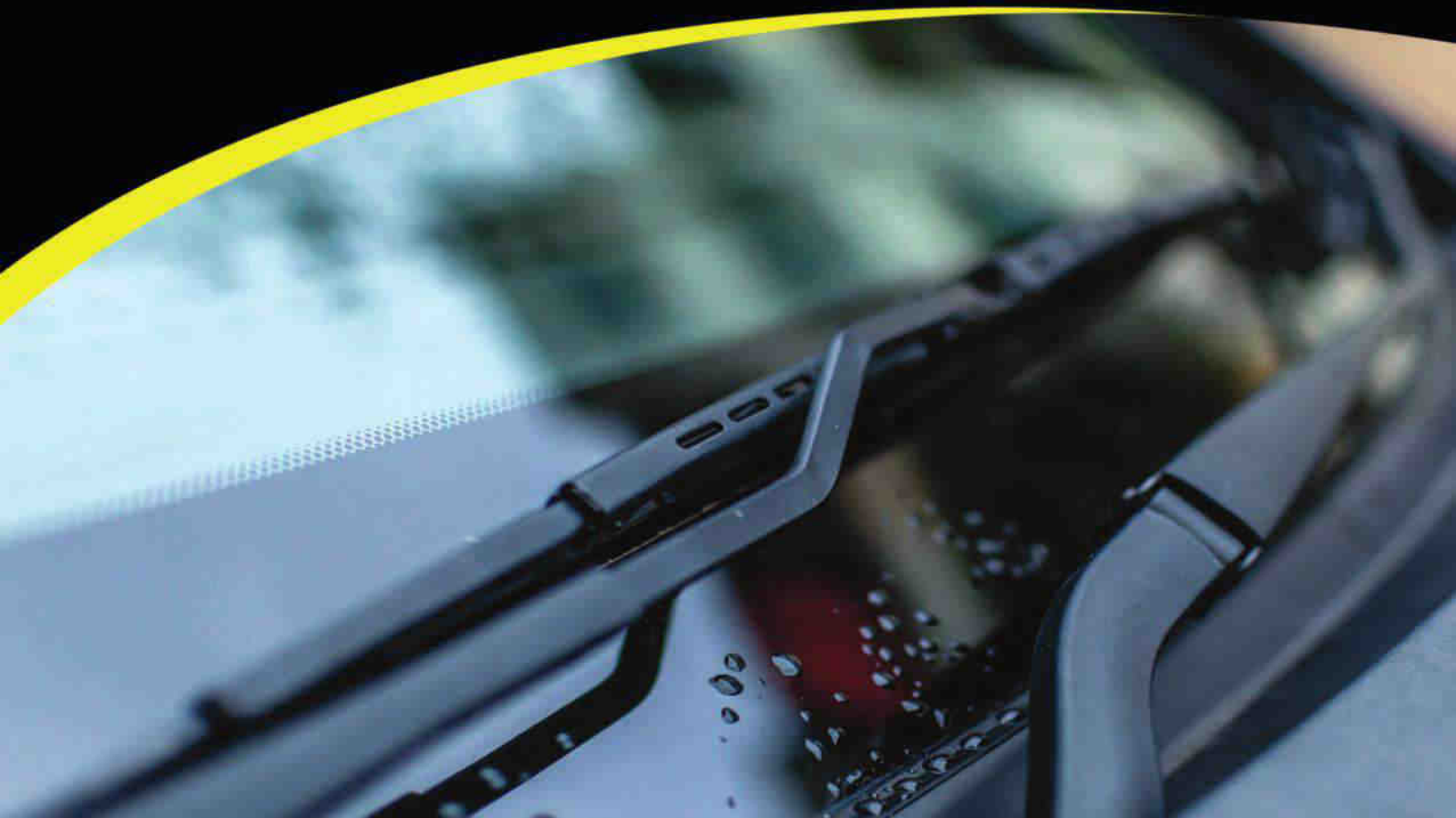

Accessori Esterni

no rain
6

SPAZZOLE UNIVERSALI FLAT CON 12 ADATTATORI
APPLICABILITÀ: LATO GUIDA / LATO PASSEGGERO / TERGILUNOTTO

COD.	pollici	mm	12 ADATTATORI			
6W300	12"	300 mm	 F20	NEW  F21	NEW  F22	
6W330	13"	330 mm		 F24	 F25	 F26
6W350	14"	350 mm			 N7	 F27
6W380	15"	380 mm	 F29			 F30
6W410	16"	410 mm				
6W430	17"	430 mm				
6W450	18"	450 mm				
6W480	19"	480 mm				
6W500	20"	500 mm				
6W530	21"	530 mm				
6W550	22"	550 mm				
6W580	23"	580 mm				
6W600	24"	600 mm				
6W630	25"	630 mm				
6W650	26"	650 mm				
6W680	27"	680 mm				
6W700	28"	700 mm				
6W750	29"	750 mm				
6W800	30"	800 mm				

Gomma di ultimissima generazione
prodotta con elastomero

Perfetta protezione ai raggi ultravioletti

Massima silenziosità

Altissime prestazioni

Perfetta protezione ai raggi ultravioletti

DUPONT



SPAZZOLA TERGICRISTALLO
lato guida



SPAZZOLA TERGICRISTALLO
lato passeggero



no rain
6

Perfetta pressione · bilanciatura

prodotto in alluminio
e acciaio inox
di qualità superiore

Accessori Esterni

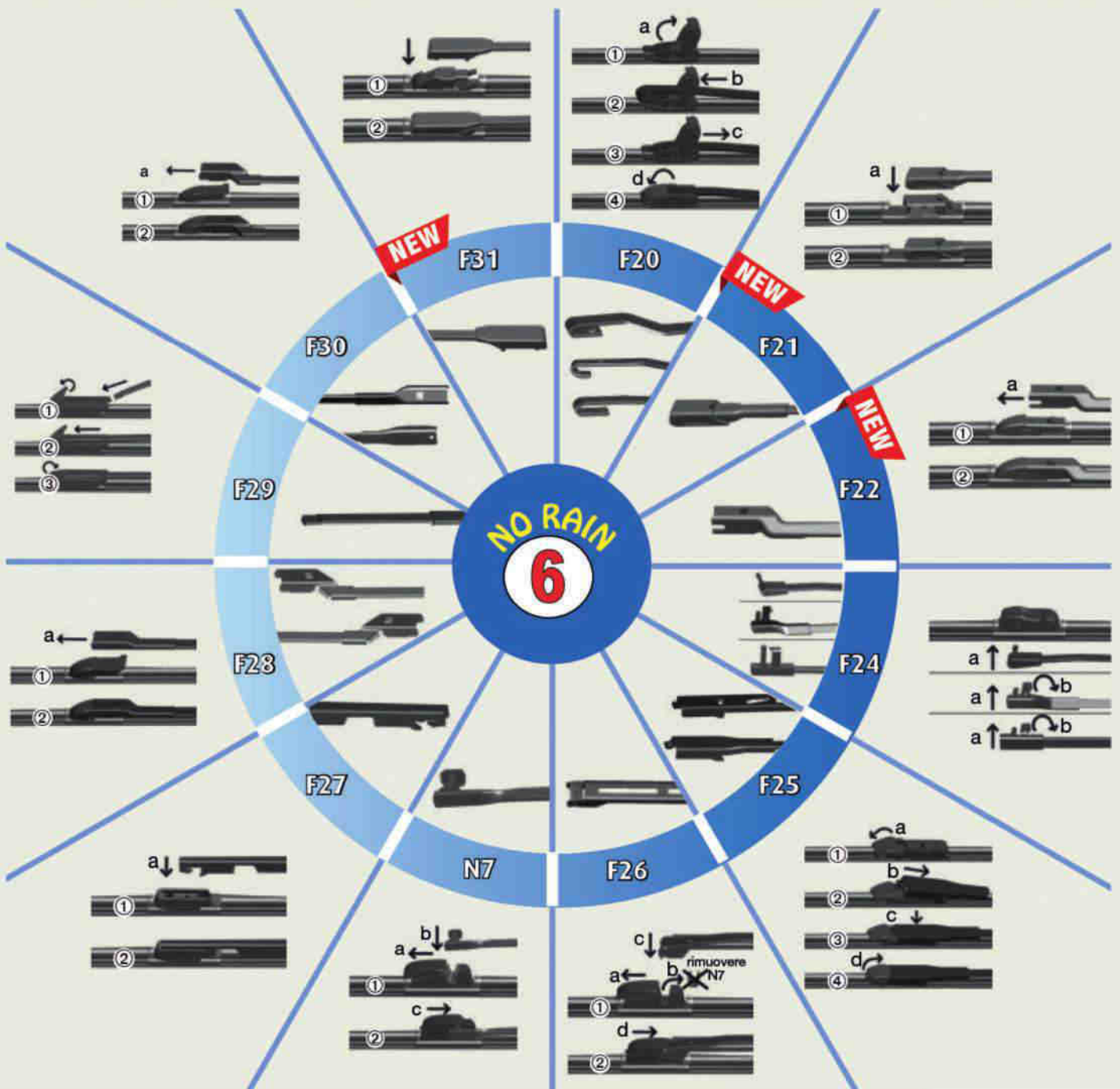

Refill Tergicristallo

Art. V0001



8 008144 018020

Refill. Gommini
di ricambio tergicristallo.
Conf. 2 pezzi in blister
610 mm

Art. V0002



8 028224 005160

Refill. Gommini
di ricambio tergicristallo.
Conf. 2 pezzi in blister
710 mm



Rear Wiper Blade

**SPAZZOLA TERGICRISTALLO
POSTERIORE UNIVERSALE
10 Attacchi art. CA10R...**

CA10R280	mm.	280
CA10R300	mm.	300
CA10R330	mm.	325
CA10R350	mm.	350
CA10R380	mm.	380
CA10R400	mm.	400



CA7L280	mm.	280
CA7L300	mm.	300
CA7L330	mm.	325
CA7L350	mm.	350
CA7L380	mm.	380
CA7L400	mm.	400

**SPAZZOLA TERGICRISTALLO POSTERIORE
UNIVERSALE Flat Wiper
7 Attacchi art. CA7L...**



Accessori Esterni

MINIGRAFFIO DISPONIBILE NEI SEGUENTI FORMATI:



2 PZ CM 65 NEL CARTONCINO

Articolo Colore

241N.360	nero
241G.360	grigio
241T.360*	trasparente
241C.360	cromato
241B.360	bianco

Imballo: 25 confezioni

Salvaporte ad incastro con adesivo butilico
resistente a temperature elevate

* con adesivo Hot-melt

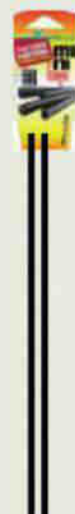

2 PZ CON FASCETTA Articolo

Lungh. Colore

241N.650	65 cm	nero
241N.700	70 cm	nero
241N.800	80 cm	nero
241G.650	65 cm	grigio
241T.650*	65 cm	trasparente
241C.650	65 cm	cromato
241B.650	65 cm	bianco

Imballo: 100 confezioni

IL SALVAPORTIERE CHE NON TEME IL CALDO!!

MINIGRAFFIO80

ESPOSITORE 100 PZ CM 80

Articolo Colore

241N.380	nero
----------	------

Imballo: 4 espositori



ART. 241



ANTIGRAFFIO

ANTIGRAFFIO CM 65

Articolo Colore

384N.322	nero
----------	------

Imballo: tubo da 50 pezzi

Salvaporte verticale universale
di spessore ridotto

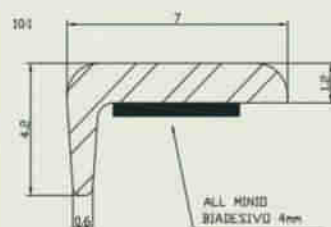

ART. 384



GRAFFIOSTOP CON BASE IN ALLUMINIO

ESPOSITORE: 20 CONFEZIONI

Articolo Colore

852N.314*	nero
852G.314	grigio
852B.314*	bianco

Imballo: 60 confezioni

Salvaporte verticale Universale
con base in alluminio* e biadesivo 3M

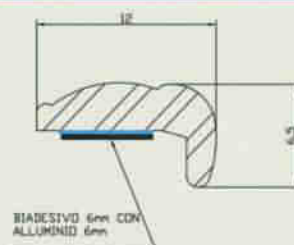

ART. 852

3M
ADH

NUOVA LUNGHEZZA m 1,40

DECORAZIONE PORTELLONE

DOOR PROTECTION

PROFILO CROMATO PER PORTELLONE

Articolo	Effetto	Lunghezza
388C.2600	cromo	2,6 m
725C.2600	cromo	2,6 m



3M
ADHESIVE

DOOR PROTECTION OFFRE PROTEZIONE ED ELEGANZA!

Facile da applicare, grazie all'adesivo 3M ad alta tenuta, può essere rifinito in modo specifico sul portellone di qualsiasi automobile.

Imballo: 4 confezioni

PROTEZIONE PARAURTI

PUMP'S

LA PROTEZIONE TOTALE

Articolo	Colore	Largh.	Lungh.	Terminali
890.371	nero	47 mm	5 m	
890G.371	grigio	47 mm	5 m	
891.371	nero	32 mm	5 m	Senza Terminali
262.371	nero	23 mm	5 m	
219.371	nero	15 mm	5 m	
383C.371	cromo	39 mm	5 m	

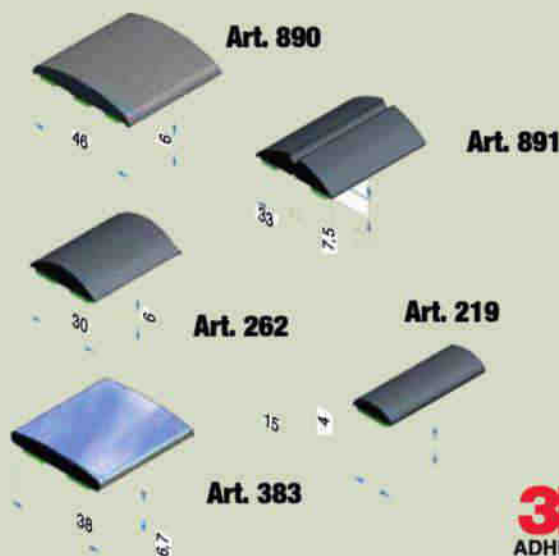

3M
ADHESIVE

Imballo: 4 confezioni

PVC di alta qualità, con base in alluminio per una tenuta ottimale nel tempo. Adesivo 3M ad alta tenuta. Con terminali.

PROTEZIONE TOTALE
SU TUTTO IL PARAURTI E LE FIANCATE DELL'AUTO



Art. 890.371

Accessori Esterni



Kit 1 barre rettangolari 30 x 20

BS 112 Barre cm. 112

BS 130 Barre cm. 130

BS 150 Barre cm. 150



Kit 1 PRO barre ovali

BSP 112 Barre cm. 112

BSP 130 Barre cm. 130

BSP 150 Barre cm. 150

Sezione barre acciaio
rettangolari / ovali mm. 2,5



K39

car parts



Kit 1 Pro Alu

BAP 112 Barre cm. 112

BAP 130 Barre cm. 130

BAP 150 Barre cm. 150

barre alluminio cover lusso



kit k1>50

kit attacchi di fissaggio



K1

ART. BS112	cm. 112
ART. BS130	cm. 130
ART. BS150	cm. 150



K1 MEDIUM

ART. BSM112	cm. 112
ART. BSM130	cm. 130
ART. BSM150	cm. 150



K1 PRO

ART. BSP112	cm. 112
ART. BSP130	cm. 130
ART. BSP150	cm. 150

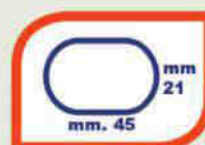

K1 PRO ALU

ART. BAP112	cm. 112
ART. BAP130	cm. 130
ART. BAP150	cm. 150



BARRE DA TETTO
ROOF BARS
BARRAS DE TECHO
BARRES DE TOIT
DACHTRÄGER

MENABO
free time on the move

OMEGA

Sistema componibile di barre portatutto per veicoli senza rails. Grazie ai molteplici kit di fissaggio e alle varianti di profili, si ha una soluzione per ogni veicolo.

Modular system of roof bars for vehicles without rails. Thanks to the wide range of fixing kits and profile variants, there is a solution for every vehicle.



COMPLIANT WITH
DIN 75302:2019

COMPLIANT WITH
ISO/PAS 11154:2006

TESTED
CITY CRASH



Tetti auto compatibili Compatible vehicle roof types



4 punti di fissaggio predisposti coperti da cover o sportelli in plastica.

Roof equipped with 4 fixed points usually covered by plastic caps.



Tetto liscio senza punti di fissaggio predisposti.

Smooth roof without fixing points.



[I] Scansiona il codice per verificare che il prodotto sia compatibile con la tua auto.
[EN] Scan the code to verify if the product is compatible with your car.

Accessori Esterni

BARRE DA TETTO
ROOF BARS
BARRAS DE TECHO
BARRES DE TOIT
DACHTRÄGER

MENABO

free time on the move

MAIN KIT

Coppia di profili in acciaio zincato rivestiti con guaina in PVC antiscivolo e antigraffio (Omega black). Disponibile anche in versione alluminio provvista di scanalatura per il montaggio rapido degli accessori con viti a "T" (Omega Alu). Completa di piedi d'aggancio regolabili con chiusura antifurto opzionale.

Pair of galvanized steel profiles covered with non-slip and scratch-proof PVC sheath (Omega black). Also available in the aluminium variant with groove for quick mounting of accessories with "T" screws (Omega Alu). Complete with adjustable hooking feet with optional anti-theft lock.

Omega black M + feet kit Art.000126700000
Omega black L + feet kit Art.000126800000
Omega black XL + feet kit Art.000126900000

Omega alu M + feet kit Art.000134600000
Omega alu L + feet kit Art.000134700000
Omega alu XL + feet kit Art.000134800000

Optional kit
000084800000



Omega black



Omega Alu

FIXING KIT

TYPE G

Kit composto da ganascine in acciaio rivestite di plastica gommata anti-graffio e basi di supporto in gomma. Portata massima : 50kg / 110lb.

Fixing kit including : steel clamps with scratch resistant plastic coating, rubber support pads.
Max load : 50kg / 110lb.



TYPE FP

Kit composto da supporti in acciaio che si fissano direttamente ai punti predisposti del tetto del veicolo. Portata massima: 75kg / 165lb.

Fixing kit including : Steel brackets to be fixed directly on the roof through its fixed points.
Max load : 75kg / 165lb.



RAPID

RAILING:
APERTO
OPEN

BARRA TELESCOPICA - TELESCOPIC BAR

Art. 831

cm. 85-135



LION

RAILING:
APERTO
OPEN

LION1 ART. 801

cm. 120

LION2 ART. 802

cm. 135



KING

RAILING:
CHIUSO
FLUSH

KING1 ART. 821 cm. 112

KING2 ART. 822 cm. 120



KIT CARGO BAR



CARGO BAR ALU

ART. 270	cm. 125
ART. 271	cm. 145
ART. 272	cm. 165
ART. 273	cm. 175



CARGO BAR



**CARGO
RULLO +
SUPPORTO**

**CARGO
ROLLER +
SUPPORT**

ART. 283	cm. 60
ART. 284	cm. 90

CARGO SPOILER

ART. 280	cm. 90
ART. 281	cm. 120



**CARGO
FERMA SCALE**

**CARGO
LADDER
FASTENING**

ART. 282	2 pcs.
----------	--------



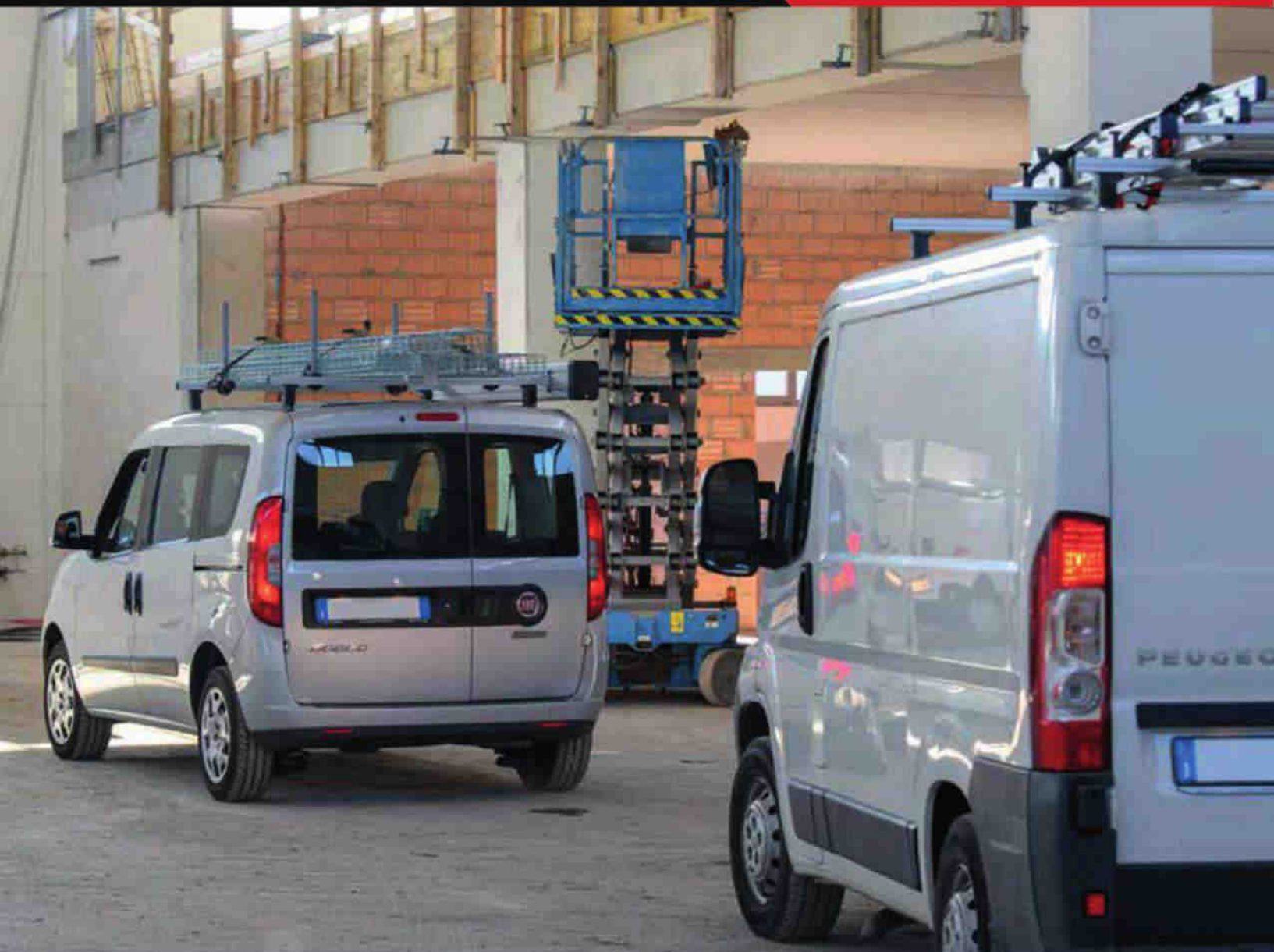

PROFESSIONAL

IT) Barre portatutto professionali studiate specificamente per veicoli commerciali. Il risultato è un sistema estremamente versatile in grado di soddisfare le vostre specifiche esigenze di trasporto in modo semplice e sicuro.

EN) Professional roof racks system designed for commercial vehicles. An extremely versatile system that fits almost all cargo needs simply and safely.



PANORAMICA DELLA BARRA ROOF BAR OVERVIEW

PROFILE KIT

IT) Profilo in alluminio leggero e resistente dotato di tre scanalature per il montaggio rapido degli accessori.

EN) Lightweight and sturdy aluminium profile with 3 slots for quick assembly of accessories.

IT) Gomma anti-fischio.
EN) Anti-whistle rubber profile.

T-System
Optional
art.000110100000

FIXING KIT

IT) Kit di installazione progettato per consentire un montaggio semplice e rapido sul veicolo. Consultando la nostra lista applicabilità è possibile selezionare il fix kit specifico.

EN) Fixing kit designed for a simple and quick installation on almost all commercial vehicles. Check MENABO PROFESSIONAL application list to select the right kit for your vehicle.



COMPLIANT WITH
DIN 75302:1991

Accessori Esterni

PROFILE KIT (1 pc)

IT) Profilo in alluminio con design a tripla scanalatura per garantire la massima adattabilità d'uso. E' possibile combinare tra loro i diversi accessori per poterli usare separatamente o tutti assieme.

EN) Aluminium profile with three slots to grant the utmost flexibility. It is possible to combine several accessories to be used together or separately.

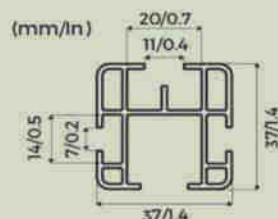
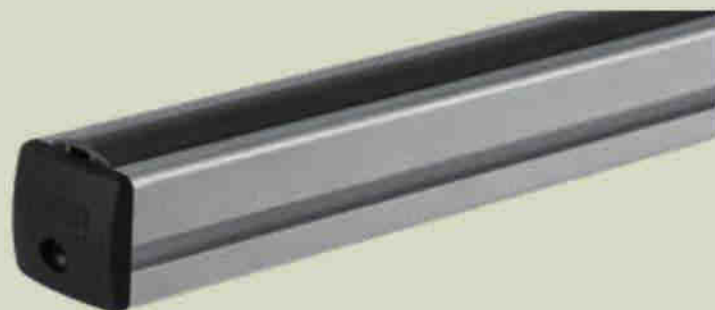

T-System



Optional Art.000110100000

M Art. 000084200000

L Art. 000084300000

XL Art. 000084400000

XXL Art. 000084500000

FIXING KIT (2 pcs)

IT) Kit di installazione composto da 4 elementi: una base universale, una staffa di fissaggio, una copertura protettiva e una cover.

EN) Fixing kit made of four components: a universal base, a steel bracket, an inner protection cover and an outer cover.

OPTIONAL
Art. 000084800000
IT) Kit serratura antifurto
EN) Antitheft lock

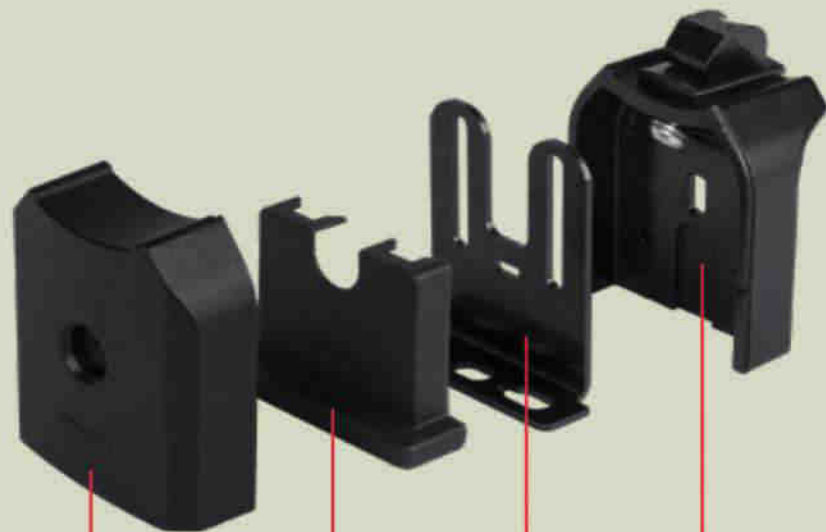

IT) Cover con chiusura a brugola.
EN) Cover with outer key fastening.

IT) Copertura protettiva.
EN) Inner protection cover.

IT) Staffa di fissaggio.
EN) Steel bracket.

IT) Base universale.
EN) Universal base.



IT) Ogni barra ha una portata massima di 50kg/110lb. A seconda del veicolo, sono installabili fino ad un massimo di 6 barre, per una portata totale di 150kg/330lb.

EN) Each bar has a max.load capacity of 50 kg/110lb. Depending on the vehicle, up to 6 bars can be installed for a total maximum load of 150 kg/330lb.



IT) Grazie al suo design è possibile regolare l'inclinazione e l'altezza di ogni barra per trasportare in maniera sicura qualsiasi tipo di carico.

EN) Thanks to its design, it is possible to change the angle and the height of each bar, thus allowing a safe cargo of any kind of load.

HOLIDAY

Art.
402



TRAVEL

Art.
401



MAK3

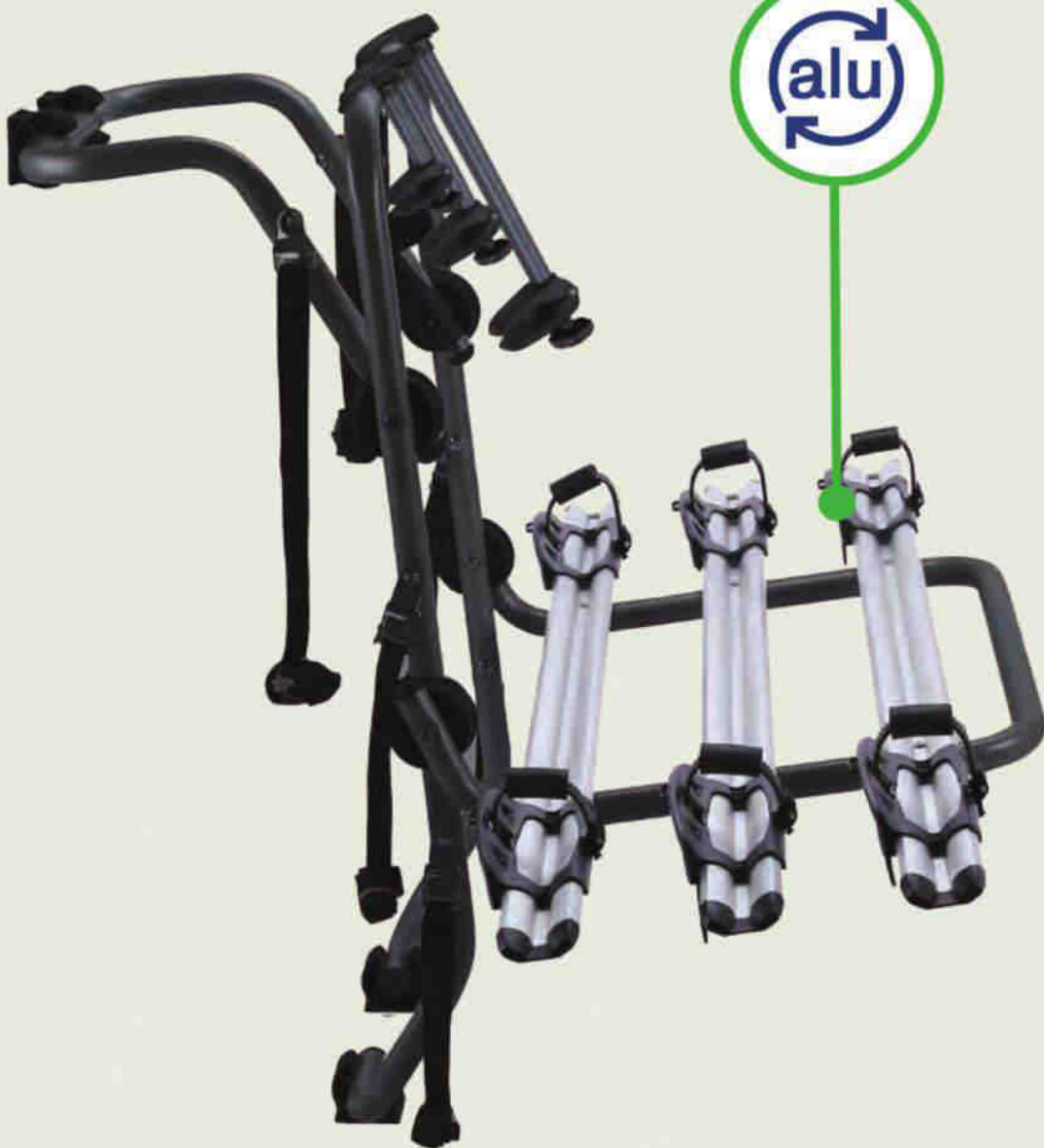

**Art.
403**



Accessori Esterni



POLARIS

Polaris (2 bici)

Art.000077900000

Polaris 3 (3 bici)

Art.00089300000

IT Portabici posteriore con struttura in acciaio e corsie in alluminio. Grazie all'innovativa staffa ferma ruota è studiato per le fat bike. E' dotato di un sistema di fissaggio senza cinghie, unico nel suo genere, che fa del Polaris il porta biciclette più sicuro della categoria. Disponibile nei modelli **Polaris*** e **Polaris 3****



COMPLIANT WITH
DIN 75302

COMPLIANT WITH
XP R18-904-4:2008
clauses 4.6, 4.7, 4.8

TÜV
TESTED ✓



MIN : Ø30 mm
MAX : Ø50 mm



MAX : 110 mm

MIN : 30x30 mm
MAX : 50x70 mm



MIN : 22"
MAX : 29"



MAX : 114 cm



LOGIC

Art. 000037900000 -

Portabici posteriore in acciaio 2 bici



LOGIC 3

Art. 000039200000 -

Portabici posteriore in acciaio 3 bici



VIPER

Art. 000123800000

Portabici posteriore in acciaio
3 biciclette fissate al supporto
ferma telaio.



ORION

Art. 301



SAGITTAR



Art. 302



FARAD MAIRA

Il portabiciclette FARAD MAIRA è preassemblato pronto all'uso, adattabile sulle barre di dimensioni massime 80 x 40 mm. Le braccia blocca bici sono dotate di sistema antifurto con chiave. Medesimo sistema viene usato anche per il fissaggio sulle barre trasversali. Le cinghie regolabili e scorrevoli fissano ruote da corsa, MTB e FAT-bike.



SCHEDA TECNICA

Portaggio massimo (Kg) 25
Interasse massimo ruote bici (cm) 135
Dimensione max fissaggio barre (mm) 80 x 40
Serratura antifurto Inclusa
Materiale Acciaio
Vite a T Non inclusa - accessorio
Garanzia 3 anni
Colore Grigio metallizzato
Omologa TÜV-GS / City-Crash
Peso prodotto (kg) 3,5
Luogo di fabbricazione Torino - Italia

FARAD PESIO

Il portabiciclette FARAD PESIO è preassemblato pronto all'uso, adattabile sulle barre di dimensioni massime 80 x 40 mm. Le braccia blocca bici sono dotate di sistema antifurto con chiave. Medesimo sistema viene usato anche per il fissaggio sulle barre trasversali. Le cinghie regolabili e scorrevoli fissano ruote da corsa, MTB e FAT-bike.

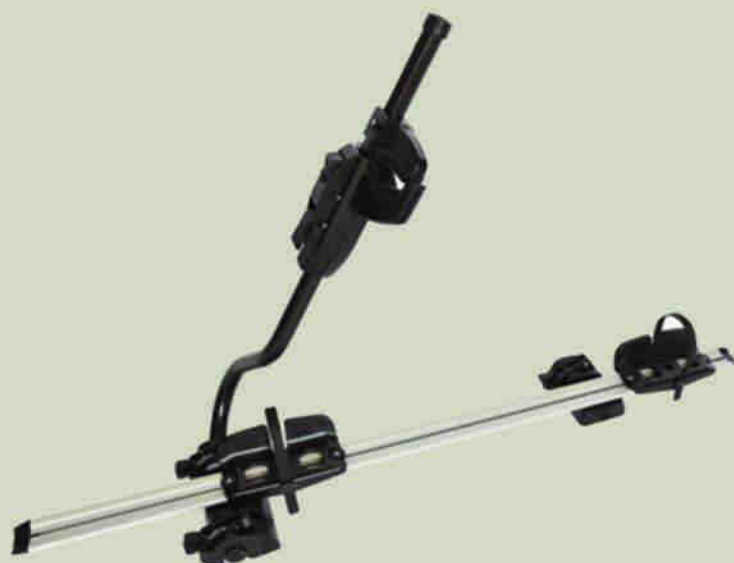

SCHEDA TECNICA

Portaggio massimo (Kg) 25
Interasse massimo ruote bici (cm) 135
Dimensione max fissaggio barre (mm) 80 x 40
Serratura antifurto Inclusa
Materiale Acciaio
Vite a U Non inclusa - accessorio
Garanzia 3 anni
Colore Grigio metallizzato
Omologa TÜV-GS / City-Crash
Peso prodotto (kg) 3,5
Luogo di fabbricazione Torino - Italia



PRO TOUR

000086100000

IT Portabicicli da tetto professionale realizzato in alluminio, pensato per chi preferisce caricare la propria bici direttamente sulle barre. È dotato di un sistema di aggancio della forcella sia tradizionale che ammortizzato. Consigliato per le bici con telaio in carbonio e indicato anche per quelle con freno a disco anteriore. Installazione direttamente in cava con sistema standard a "T" 20mm.

EN Professional roof bike carrier made of aluminium. Conceived for those who prefer carrying their bikes directly on the roof bars. The fixing system fits both the traditional and the cushioned fork. Recommended for bikes with carbon frame and for bikes with front disc brake. To be fixed directly in the slot in the roof bars with a standard 20mm T-System.



COMPLIANT WITH
DIN 75302

TUV
TESTED

COMPLIANT WITH
ISO/PAS 11154:2006
clauses 5.2.5, 5.3.5

Pro Tour va abbinato ad almeno uno dei seguenti kit / Pro Tour features 4 fork adapters



• Quick
release kit
000086800000



• 15 mm
Thru Axle
000086900000



• 20 mm
Thru Axle
000087000000



• Rockshox Bluto
standard
000087100000



SIRIO



IT) Portabici da gancio adatto a qualsiasi tipo di bici. Realizzato esclusivamente in alluminio e materiali pregiati, è progettato per rispondere ai più alti standard di sicurezza, senza tralasciare il design. Dotato di doppio sistema antifurto



Sirio
Art. 000089100000



Sirio plus
Art. 000089200000



Art. 000095200000+



ANTARES

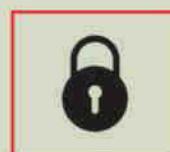

Antares
Art. 000105000000



Antares plus Art.
000103400000



ALCOR



Alcor
Art. 000113000000



Alcor 3
Art. 000112700000



Alcor 4
Art. 000118300000



MERAK

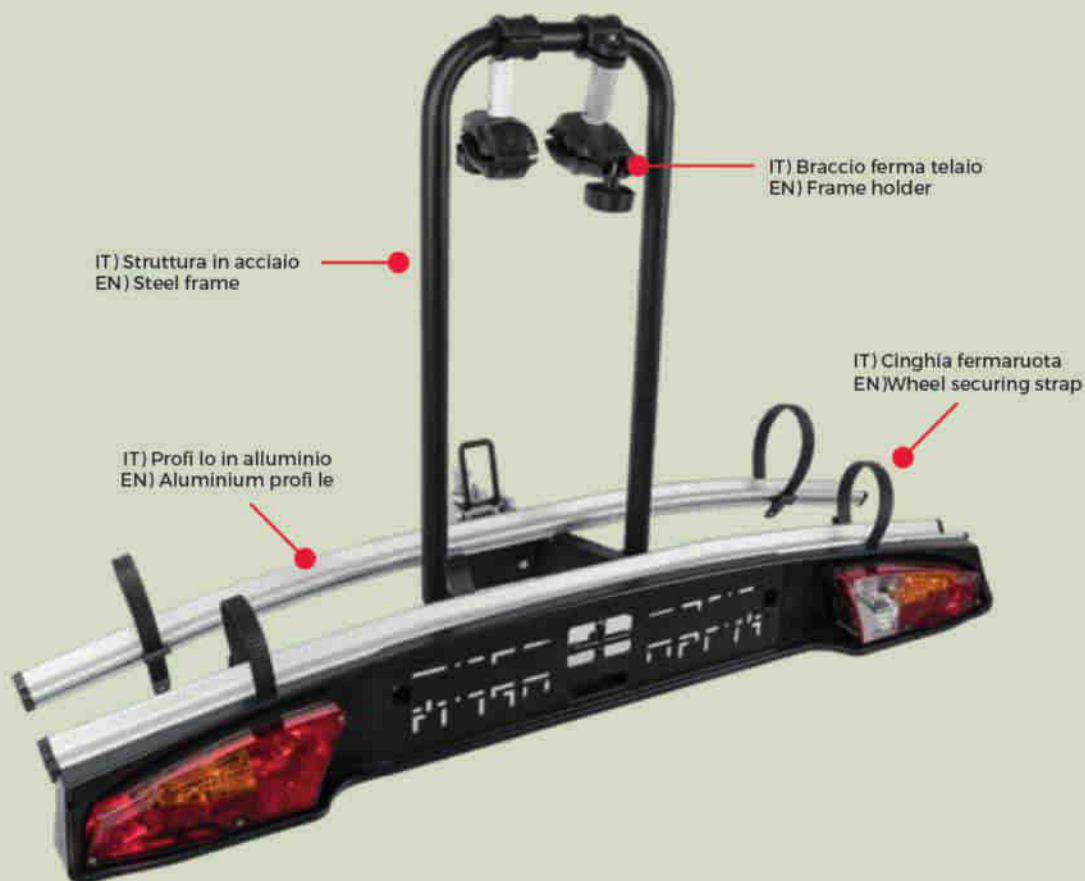

IT) Portabici da gancio compatto e leggero con profili in alluminio. Disponibile in 3 versioni.

EN) Compact and lightweight towbar bike rack with aluminium rails. Available in three models.



Merak
Art. 000117600000



Art. 000117800000



Merak tilting
Art. 000117700000



Art. 000117800000



Merak rapid Art.
000119100000



Art. 000117800000



COMPACT AND LIGHTWEIGHT TOWBAR BIKE RACK,
QUICK AND EASY TO INSTALL ON YOUR TOWBAR.
CARRY UP 1 OR 2 BIKES. LOAD CAPACITY: 30 KG.
PRE-ASSEMBLED, TOOL-FREE INSTALLATION AND REMOVAL.

PORTABICI DA GANCIO TRAINO COMPATTO E LEGGERO
CHE SI FISSA AL GANCIO TRAINO IN POCHI SECONDI.
DISPONIBILE PER 1 O 2 BICI. CAPACITÀ DI CARICO: 30 KG.
GIÀ ASSEMBLATO NON OCCORRONO UTENSILI.

VARAITA



FOR ONE BIKE
PER UNA BICI

FOR TWO BIKES
PER DUE BICI

WITH LICENSE PLATE HOLDER
CON PORTATARGA

WITH LICENSE PLATE HOLDER + LIGHTS
CON PORTATARGA + FANALI



FARAD

Accessori Esterni



PRE-ASSEMBLED

- **SIME PER AUTO CON CORRIMANO**
SIME FOR CARS WITH ROOF RAILS
SIME POUR VOITURES AVEC BARRES LONGITUDINALES
SIME FÜR AUTOS MIT RAILING



SIME

PRE-ASSEMBLED

- **BEAMAR PER AUTO CON CORRIMANO BASSO**
BEAMAR FOR CARS WITH INTEGRATED ROOF RAILS
BEAMAR POUR VOITURES AVEC BARRES LONGITUDINALES BASSES
BEAMAR FÜR AUTOS MIT NIEDRIGEN RAILING



BEAMAR



ALU + KIT SM



ALU + KIT DM



ALU + KIT BS



ALU + KIT

- **ALU PROFILO ALLUMINIO**
ALU FOR CARS WITHOUT ROOF RAILS
ALU POUR VOITURES SANS BARRES
LONGITUDINALES
ALU FÜR AUTOS OHNE RAILING



SIME PRE-ASSEMBLED

BEAMAR PRE-ASSEMBLED

ALU

SPECIFICHE TECNICHE - TECHNICAL FEATURES - FICHE TECHNIQUE - TECHNISCHE MERKMALE

	LUNGHEZZA CM LENGTH CM LONGUEUR CM LÄNGE CM					ALTEZZA BARRA MM BAR'S HEIGHT MM HAUTEUR DE LA BARRE MM DACHTRÄGERHÖHE MM	CARICO MASSIMO KG MAXIMUM LOAD KG PORTAGE MAXIMUM KG MAXIMALE TRAGKRAFT KG	KIT DI FISSAGGIO RICHIESTO FIXING SYSTEM REQUIRED KIT DE FIXATION REQUIS BESESTIGUNGSSYSTEM NOT WENDIG	MONTAGGIO SENZA UTENSILI NO TOOLS REQUIRED MONTAGE SANS OUTILS MONTAGE OHNE WERKZEUG	SERRATURA INCLUSA LOCKING SYSTEM INCLUDED FERMETURE DE SÉCURITÉ INCLUE SICHERHEITSSCHLOSS
	110	120	130	140	160					
SIME	x	x	x	x	x	45	100		x	x
BEAMAR	x	x	x			50	100		x	x
ALU	x	x	x	x	x	30	100	x	x	

IRON



FARAD

IRON + KIT SM

IRON + KIT BM

IRON + KIT BS

BARIS

-  Estrema facilità di montaggio, eleganza e sicurezza sono le parole chiave delle barre FARAD.
-  Easy fitting, elegance and safety: these are the key words of the FARAD roof bars.
-  Facilité de montage, élégance et sécurité sont les mots-clés des barres de toit FARAD.
-  Einfache Befestigung, Eleganz und Sicherheit sind die Schlüsselwörter der FARAD Dachträger.

Accessori Esterni



IRON PER AUTO CON CORRIMANO
 IRON FOR CARS WITH ROOF RAILS
 IRON POUR VOITURES AVEC BARRES LONGITUDINALES
 IRON FÜR AUTOS MIT RAILING



IRON PER AUTO CON CORRIMANO BASSO
 IRON FOR CARS WITH INTEGRATED ROOF RAILS
 IRON POUR VOITURES AVEC BARRES
 LONGITUDINALES BASSES
 IRON FÜR AUTOS MIT NIEDRIGEN RAILING



IRON PER AUTO SENZA CORRIMANO
 IRON FOR CARS WITHOUT ROOF RAILS
 IRON POUR VOITURES SANS BARRES LONGITUDINALES
 IRON FÜR AUTOS OHNE RAILING



SPECIFICHE TECNICHE - TECHNICAL FEATURES - FICHE TECHNIQUE - TECHNISCHE MERKMALE

	110	120	130	140	160	ALTEZZA BARRA MM BAR'S HEIGHT MM HAUTEUR DE LA BARRE MM DACHTRÄGERHÖHE MM	CARICO MASSIMO KG MAXIMUM LOAD KG PORTAGE MAXIMUM KG MAXIMALE TRAGKRAFT KG	KIT DI FISSAGGIO RICHIESTO FIXING SYSTEM REQUIRED KIT DE FIXATION REQUIS BESESTIGUNGSSYSTEM NOT WENDIG	MONTAGGIO SENZA UTENSILI NO TOOLS REQUIRED MONTAGE SANS OUTILS MONTAGE OHNE WERKZEUG
IRON	x	x	x	x		20	75	x	x

VI PRESENTIAMO IL NUOVO KIT PER AUTO CON CORRIMANO ALTO
E BASSO, COMPATIBILE CON TUTTE LE BARRE FARAD

KIT HILO

1-92041 HILO

E ALTRE MARCHE
AVENTI CAVA
DI SEZIONE
SIMILARE PER
SCORRIMENTO
PIEDE HILO



DISPONIBILE ANCHE PREMONTATO SU BARRE FARAD IRON 3 TELESCOPICHE

HILOPLUS

1-92041/2 HILOPLUS SH (SHORT)

1-92041/3 HILOPLUS LG (LONG)



ALLEGATO LISTA APPLICAZIONI

FARAD
MADE IN ITALY

Accessori Esterni

MARLIN F3



COLORI DISPONIBILI

Grigio gofrato

Grigio metallizzato

Nero lucido

Nero gofrato

Bianco

TYPE N.6



TYPE N.7



TYPE N.8



TYPE N.11



Modello	Litri	Dimensioni esterne	Dimensioni interne	Carico massimo auto	Carico massimo camper	Kg.
TYPE N.6	480	190X80X40	184X73	75	90	15
TYPE N.7	680	210X100X42	198X92	75	90	21
TYPE N.8	400	160X80X40	154X73	75	90	13
TYPE N.11	530	225X80X42	215X70	75	90	18

ZELUS



COLORI DISPONIBILI



Grigio gofrato

Grigio metallizzato

Nero lucido

Nero gofrato

Bianco

TYPE N.15



TYPE N.16



TYPE N.17



Modello	Litri	Dimensioni esterne	Dimensioni interne	Carico massimo auto	Carico massimo camper	Kg.
TYPE N.15	400	160X85X40	153X78	75	90	12,5
TYPE N.16	480	190X80X42	182X72	75	90	14
TYPE N.17	630	210X90X42	201X83	75	90	17,5

koral



COLORI DISPONIBILI

Grigio goffrato

Grigio metallizzato

Nero lucido

Nero goffrato

Bianco

TYPE N. 19

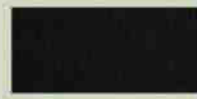
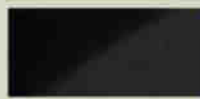

TYPE N. 20

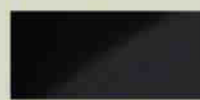

TYPE N. 21

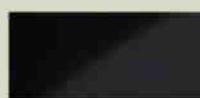

Modello	Litri	Dimensioni Esterne	Dimensioni interne	Carico massimo auto	Carico massimo camper	Peso Kg.
TYPE N.19	400	160X80X40	153X78	75	90	12,5
TYPE N.20	480	190X80X40	182X72	75	90	14
TYPE N.21	630	210X90X42	201X83	75	90	17,5

Crub



COLORI DISPONIBILI

Nero gofrato



Modello	Litri	Dimensioni esterne	Dimensioni interne	Carico massimo auto	Carico massimo camper	Kg.
TYPE N.18	430	180X78X40	172X73	75	90	14



DORY

**È UN PIACERE PER NOI
PRESENTARVI I NOSTRI NUOVI
BOX.**



DORY

N/22

BOX 140*75*39

Lt. 340

GOFFRATO

NERO

IL COMPAGNO DI VIAGGIO IDEALE PER LE TUE NUOVE AVVENTURE.

	LITRI	DIMENSIONI ESTERNE CM	DIMENSIONI INTERNE CM	CARICO MASSIMO PER MACCHINE KG	CARICO MASSIMO PER CAMPER KG	PESO KG	SISTEMA DI FISSAGGIO: FARAD QUICK FIX	MIN/MAX DISTANZA TRA LE BARRE CM	CHIUSURA CENTRALIZZATA	DOPPIA APERTURA	CINTURE DI FISSAGGIO	GARANZIA 5 ANNI
type n.22	340	140X75X39	134X69	75	90	12		41/71				

NEW CORAL





NEW CORAL N/23

BOX 145*95*43

Lt. 400

GOFFRATO NERO

GOFFRATO GRIGIO

NERO LUCIDO

GRIGIO LUCIDO

IL NUOVO DESIGN CORAL, MODERNO ED ACCATTIVANTE, RIDEFINISCE LA LINEA DELLA TUA AUTO.

	LITRI	DIMENSIONI ESTERNE CM	DIMENSIONI INTERNE CM	CARICO MASSIMO PER MACCHINE KG	CARICO MASSIMO PER CAMPER KG	PESO KG	SISTEMA DI FISSAGGIO: FARAD QUICK FIX	MIN/MAX DISTANZA TRA LE BARRE CM	CHIUSURA CENTRALIZZATA	DOPIA APERTURA	CINTURE DI FISSAGGIO	GARANZIA 5 ANNI
type n.19	400	160X80X40	153X58	75	90	12		36/94				
type n.20	480	190X80X40	182X72	75	90	14		30/87				
type n.21	630	210X90X42	201X83	75	90	18		39/99				

Accessori Esterni

Linea
CARBON

BAULI TETTO AUTO

I bauli auto della linea Carbon nascono dalla collaborazione con esperti nel settore automotive. Lo studio sia dell'aerodinamica che delle soluzioni degli ingombri interni è arricchito dal design sportivo ed elegante dell'effetto carbonio. Adattabile ad ogni modello di auto, montaggio facile e veloce.

ROOF BOXES

Carbon Line born thanks to the collaboration with some of best experts in automotive. The result of the study both of aerodynamic impact and internal spaces is implemented by sport and elegant design with a carbon look. Suitable for any car, easy and fast assembly.

Caratteristiche principali Main features

- Montaggio facile e veloce
Easy and fast assembly
- Economico e adattabile ad ogni auto
Economic and suitable for any car
- Prodotti in polipropilene, materiale antiurto, resistente al freddo, alle intemperie, agli oli e ai solventi
Produced in polypropylene, shock proof material, water proof and resistant against solvents and oils
- Prodotti con plastica riciclata, riciclabile e conforme alla normativa REACH
Produced with recycling and recyclable plastic, in compliance with REACH regulation

75Kg

Assale di chiusura
in alluminio
*Aluminium locking
system*

> Linea **CARBON**

Prodotto Italiano ecosostenibile
Eco-sustainable Italian product



prodotto in polipropilene
produced in polypropylene



non assorbe gli odori
don't absorb smells



non trattiene umidità
don't keep humidity



semplice sistema di assemblaggio
easy assembly system

Chiusura di sicurezza anteriore
Front safety lock



Supporti in acciaio al 100%
100% steel parts

BA320

Effetto carbonio ad alta definizione
High definition carbon fiber texture

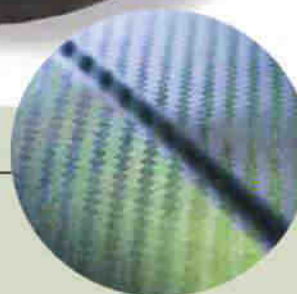

Sollevatori a molla
Spring lifters

Predisposto per tutti gli interassi
(min 495 mm max 855 mm)
Predisposed for every distances
(min 495 mm max 855 mm)



55Kg

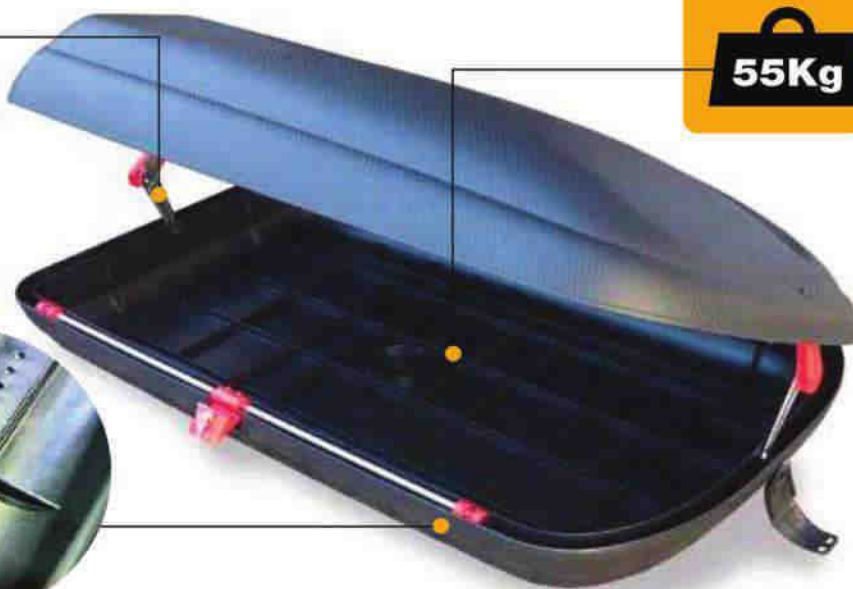

AUTO-BICI
AUTOMOTIVE

ARTICOLO / ARTICLE

Larghezza Width	Profondità Depth	Altezza Height	Codice a barre Barcode
BA320 1320	778	345	8010693101504

IMBALLO / PACKING

Pz. Pc.	Tipo Type	Larghezza Width	Profondità Depth	Altezza Height
1	cartone/carton	350	785	1340

Tutte le misure sono espresse in millimetri / All measures are in millimeters

> Linea **CARBON**

BAULI TETTO AUTO
ROOF BOXES

Tasto di sicurezza anteriore
Front safety button



BA480/PA



Assale di chiusura
in alluminio
Aluminium locking
system

Supporti in
acciaio al 100%
100% steel
parts



Accessori Esterni



prodotto in polipropilene
produced in polypropylene



non assorbe gli odori
don't absorb smells



non trattiene umidità
don't keep humidity



semplice sistema di assemblaggio
easy assembly system

Prodotto italiano ecosostenibile
Eco-sustainable Italian product



Sollevatori a molla
Spring lifters



Effetto carbonio ad alta definizione
High definition carbon fiber texture

75Kg



AUTO-BICI
AUTOMOTIVE

Predisposto per tutti gli interassi
(min 495 mm max 855 mm)

Predisposed for every distances
(min 495 mm max 855 mm)

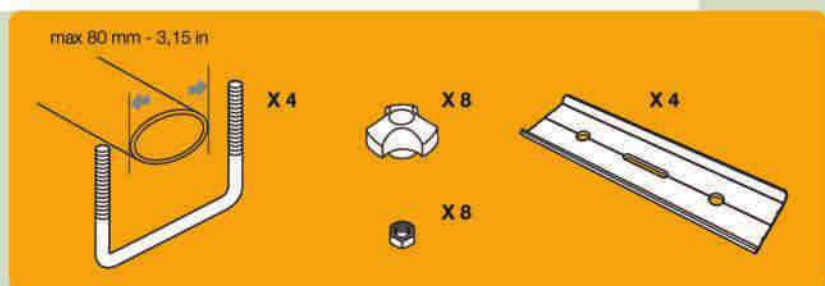

ARTICOLO / ARTICLE

Larghezza	Profondità	Altezza	Codice a barre
Width	Depth	Height	Barcode
BA480/PA 2005	790	380	8010693118205

IMBALLO / PACKING

Pz.	Tipo	Larghezza	Profondità	Altezza
Pc.	Type	Width	Depth	Height
1	cartone/carton	800	285	2040

Tutte le misure sono espresse in millimetri / All measures are in millimeters

Accessori Esterni





FURGONI e AUTOCARRI

Vans and Truck
Fourgons et Camions

 **S.I.E.**

VETRI DI RICAMBIO E SPECCHI RETROVISORI

Per tutti i prodotti scarica il catalogo da www.robortobotteghisas.it



TRATTORI e MACCHINE MOVIMENTO TERRA

Tractors and Earth-Moving Machinery
Tracteurs et Engins de Chantier

 **S.I.E.**

VETRI DI RICAMBIO E SPECCHI RETROVISORI

Per tutti i prodotti scarica il catalogo da www.robortobotteghisas.it



***DISTRIBUTORE DI SPECCHI RETROVISORI GRUPPI OTTICI E FARI
POSTERIORI PER AUTO ITALIANE ED ESTERE***

ricam
retrovisori



***Per applicazioni visitare sito
www.ricam.it***

RICAMBI AUTO



ACCESSORI FAMAC

- Retrovisori
- Fodere sedili
- Capotte
- Pannelli porte
- Tappeti
- Fregi
- Pantina parasole
- Portaoggetti posteriore
- Scritte



AUTO D'EPOCA

- Lamierati
- Fanaleria ant. / post.
- Retrovisori
- Fodere sedili
- Capotte
- Pannelli porta
- Tappeti
- Fregi
- etc.



ALZACRISTALLI E MANIGLIE

- Elettrico / Manuale
- Meccanismo
- Porta / Serrature
- Scontri



MOLLE A GAS PER COFANI E PORTELLONI



CERCHI RUOTA IN METALLO



COLLANTI PER VETRI

DEPO-TYC ILLUMINAZIONE

- Adattabile all'originale



COPPE RUOTA NYLON

- Adattabile all'originale



FIAT - ALFA LANCIA ROMEO

- Materiale originale





**ROBERTO
BOTTEGHI**

www.botteghicarrozzerie.it

ILLUMINAZIONE PRIMO IMPIANTO

- Hella
- Marelli
- Valeo



LAMIERATO

- Porte
- Cofani / Portelloni
- Fianchi / Parafanghi
- Tiranti porte / Sottoporta
- Ossatura anteriore



MATERIALE MIRAGLIO

- Maniglie interne/esterne
- Serrature
- Blocchetti con chiavi
- Meccanismo alzacrystallo
- Alzacristalli



MODANATURE LATERALI

- Passaruota



PARAURTI GRIGLIE - LOCARI SOTTOMOTORI

- Fregi
- Rinforzo paraurti
- Staffe paraurti



PARAURTI ORIGINALI MARELLI



RETROVISORI

- Auto
- Furgoni



SPAZZOLE E TERGI VALEO



TERMICO

- Condensatore
- Elettro ventola
- Intercooler
- Radiatore
- Riscaldatore



VETRI E GUARNIZIONI

- Parabrezza
- Lunotto
- Laterali



Accessori Interni



Coprivolante in vera pelle Nera

Art. KH 27662/36 diametro 36"
 Art. KH 27662/38 diametro 38"
 Art. KH 27662/40 diametro 40"



Coprivolante in vera pelle Beige

Art. KH 27662/36 diametro 36"
 Art. KH 27662/38 diametro 38"
 Art. KH 27662/40 diametro 40"



**COPRIVOLANTE MOMO
 CONFORT NERO E ROSSO MISURA 38/39 CM**



**COPRIVOLANTE MOMO
 CARBON E NERO MISURA 38/39 CM**



**COPRIVOLANTE MOMO
 CONFORT NERO E GRIGIO MISURA 38/39 CM**



**COPRIVOLANTE SPEED
 MISURA 37/40 CM**



**COPRIVOLANTE URBAN
 MISURA 37/40 CM**



**COPRIVOLANTE SIMPLE
 MISURA 37/40 CM**

Art. A0233



8 008144 012899

Disco orario
 controllo sosta



Art. V0157



8 016751 461641
 Pomello universale
 giravolante.
 Conf. 1 pezzo in blister



Accessori Interni



GRIGLIA DIVISORIA IN METALLO UNIVERSALE PER ANIMALI DOMESTICI

Must-have per viaggiare in completa sicurezza in compagnia dei tuoi amici a quattro zampe.

Art. EASY01



ALTEZZA DA 40,5 A 54 cm A 147 c
LARGHEZZA DA 84 cm



- Design elegante di altissima qualità.
- Facile e sicuro da installare.
- Adatto per tutti i modelli di auto.



Sistema di regolazione
telescopico,
adatto a tutte le auto



Facile da installare
senza attrezzi,
maggiore sicurezza



Nuovo sistema
di ancoraggio ai poggiatesta
posteriori

PETSY

- IT Separatore auto universale per cani
- EN Universal pet barrier for cars
- FR Grille de séparation automobile pour chien
- DE Universal Hundegitter für auto
- ES Rejilla separadora universal para perros

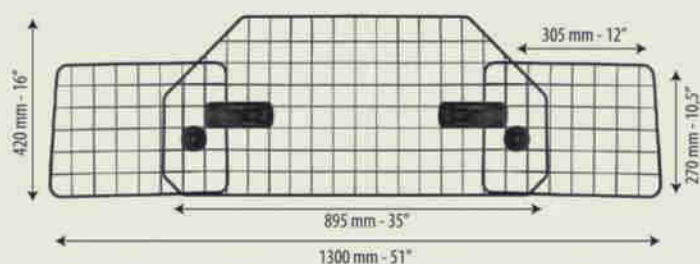
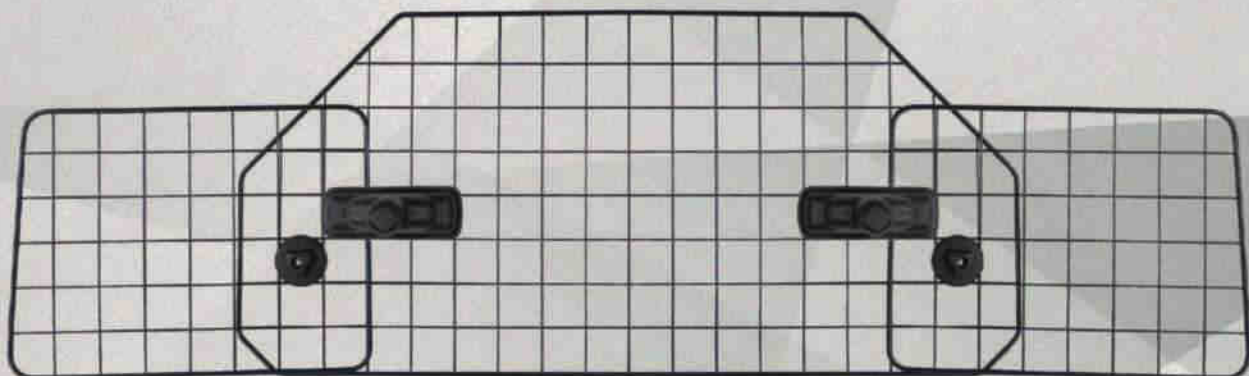

Art. ME0001173

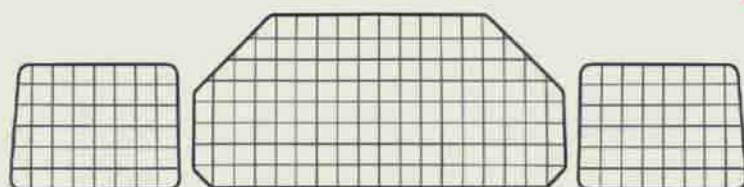

F.lli Menabò s.r.l.
Via 8 Marzo 3, 42025 Cavriago (RE), Italia
+39-0522/942840
info@flli-menabo.it www.flli-menabo.it
Made in PRC



Accessori Interni

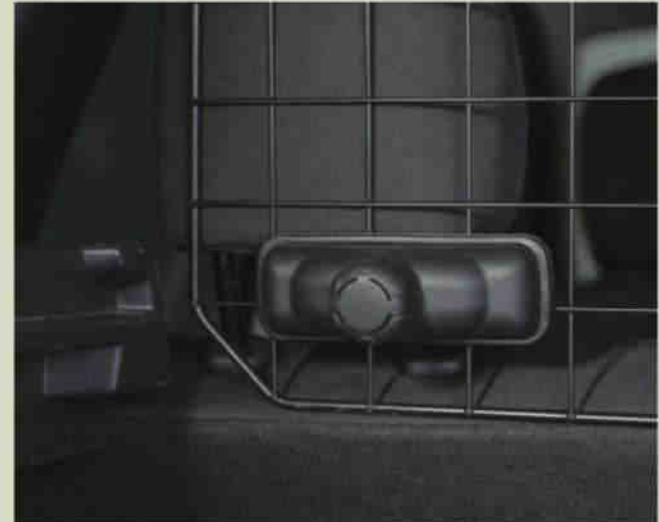

Accessori Interni



TELO A VASCA PROTEGGI SEDILI UNIVERSALE PER ANIMALI DOMESTICI

Massimo comfort del tuo amico a quattro zampe, la protezione dei sedili e degli interni della tua auto, ideale per i viaggi e piccoli spostamenti.

Art. EASY02



- Adatto per tutti i modelli di auto.
- Pratico, resistente, impermeabile e antiscivolo.
- Lavabile in lavatrice. Multiuso.



Resistente ai liquidi si pulisce con un panno



Cerniere per chiusura laterale a vasca



Rivestimento traspirante e antiscivolo



Finestrella in rete per monitorare i passeggeri



Pratica tasca richiudibile per riporre accessori



4 fibbie a scatto regolabili per fissaggio stabile



SPAZZOLA IN SILICONE ANTISTATICA MULTIUSO

Indispensabile per la rimozione dei peli degli animali da tutte le superfici in tessuto: sedili dell'auto, divani, tappeti o coperte, la spazzola antistatica è pratica, compatta e maneggevole.

Art. EASY03



- **Peso ridotto.**
- **Delicate setole in gomma.**
- **Dimensioni compatte.**



Adatta e comoda per gli interni delle auto



Ideale per sedie e poltrone in tessuto

IMPUGNATURA ERGONOMICA



SILICONE ANTISTATICO

SETOLE LAVABILI

Accessori Interni



TASCHE PORTA OGGETTI PER AUTO

Organizza, sistema ed evita la caduta di tutti gli oggetti, dando maggiore comfort al guidatore risolvendo i problemi di disordine e distrazione.

Art. EASY04



- Design elegante. Facili da pulire.
- Semplice da posizionare.
- Universali.



Universali



Ideale per lo spazio tra sedile e consolle



Art. A0099



8 008144 010215

Coprivolante "Unicover".
Conf. 1 pezzo in busta
Diametro 37-40 o 33-37 cm

Art. AP140



6 931498 100436

Coprivolante grande.
Conf. 1 pezzo in busta
Diametro 43-47 cm

Art. RB500
Tappeto universale in gomma

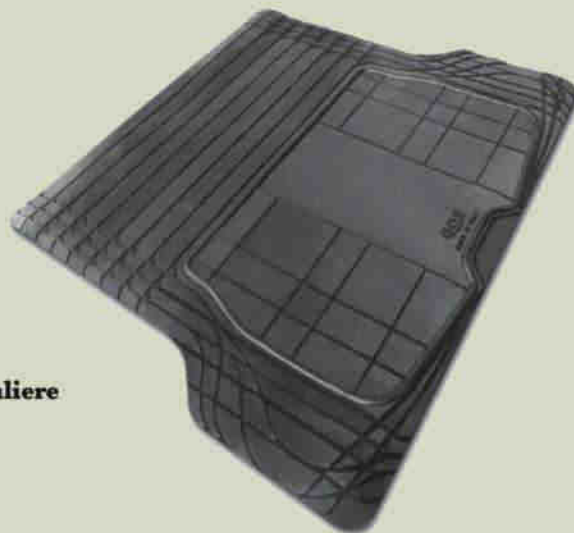

Art. RB505

Tappeto universale in gomma per bauliere

TAPPETI in GOMMA su MISURA



Art. RI1007
Fiat 500 X

Art. RI10061/6n Tappeto 500 - 126

Art. RI10063 Fiat Multipla

Art. RI1074N Fiat Doblò >2010

Art. RI1075 Fiat Doblò 2010 2pz.

Art. RI1076 Fiat Doblò 2010 4pz.



Tappeti in GOMMA su Misura



Fiat 500 dal 2007
Art:RI10005



Fiat 500 - L
Art.RI10006



SMART
Art.RI01SMT



Fiat PANDA dal 2012
Art.RI10087



Fiat GRANDE PUNTO - EVO Art.10064



FIAT PANDA fino al 2012
Art.RI10062

Tappeti e Fodere



KR213261
Tappeto in gomma
ZUBRI GLOBAL

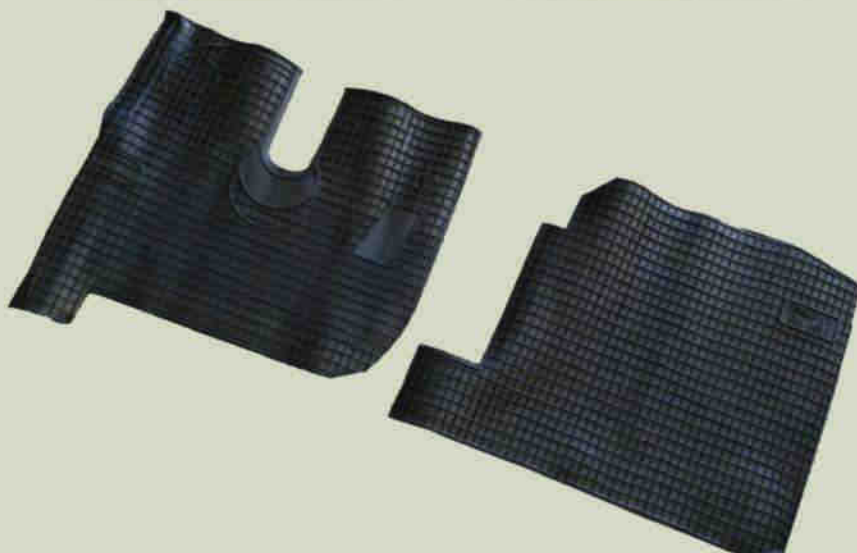

VASCA PROTEGGI BAULIERE UNIVERSALE **Bordo Rigido**



FARAD

Art. FRTYPE C	Cm. 100x90
Art. FRTYPE D	Cm. 60X40
Art. FRTYPE B	Cm. 70X90
Art. FRTYPE A	Cm. 92X52

TAPPETO IN GOMMA FURGONI AUTOCARRI

Art. RI10059	OM 170NC/190NC
Art. RI10074bis	DOBLO' VAN
Art. RI10283	TRANSIT T.T.
Art. RI1074N	DOBLO'
Art. RI10800	OM 50 T.T.
Art. RI10801bis	DAILY >99' T.T.
Art. RI10803	DUCATO 90'
Art. RI10803/2	DUCATO
Art. RI10803/3	DUCATO 94'
Art. RI10803bis	FIAT 190.38 190.42
Art. RI10807	FIAT 190.38 NT TS
Art. RI10807bis	SCUDO
Art. RI10811	FIAT 190 Turbo
Art. RI10813	FIAT 190.48 NT
Art. RI10819	FIAT EURO CARGO
Art. RI10821	FIAT EUROTECH
Art. RI10822	FIAT EUROSTAR
Art. RI10823	FIAT DAILY 2000 > U.T.
Art. RI10824	FIAT STRALIS
Art. RI10825	VW TRANSPORTER
Art. RI11224	MERCEDES SPRINT
Art. RI11300	

Tappeti e Fodere



Art. RB506

Tappeto universale in gomma reversibile



Art. RB 501



Serie tappeti gomma "Sport",
misura universale.
Conf. 2 anteriori/2 posteriori. Colore: nero



Art. RB503

Tappeto gomma universale 4 pz.
URBAN



Art. T0649



Serie tappeti gomma "Montecarlo",
misura universale.
Conf. 2 anteriori/2 posteriori.
Colore: nero

TAPPETI MOQUETTE su MISURA



Tappeti e Fodere



Art. LI032
Fiat 500 L nuovo modello



Art. LI027
Fiat 500 con ricamo



Art. LI030
Fiat Panda dal 2003 4/5 posti



Art. LI009
Fiat 500 con ricamo bicolore

Art. LI030
Fiat Panda dal 2012 4/5 posti



Art. LI010
Smart con ricamo
vecchio / nuovo modello

Art. LI020
Citroen C1-Toyota Aygo



Art. LI041
Fiat Grande Punto

Tappeti e Fodere

Art. LI023

FODERA COMPLETA
UNIVERSALE
5 POGGIATESTA
SEDILI POST. DIVISI
con CERNIERE
COMPATIBILI
CON AIR-BAG
Colori : blu, nero,
grigio, rosso,
fantasie.
BICOLORI



Art. LI033

FODERA "GIOIELLO"
ANTERIORE
UNIVERSALE
COMPATIBILI
CON AIR-BAG
Colori : blu, nero,
grigio, rosso,
fantasie.
BICOLORI



Art. LI007

Fodere "Oceania" universali
anteriori.
Conf. 2 pezzi.
Imballo: busta nylon.
Colore: nero, grigio, blu,
Fantasie assortite

PIUMONI UNIVERSALI

**COMPLETO PER DUE SEDILI CON POGGIATESTA
ADATTO A TUTTE LE STAGIONI**

Art. LI011



JOLLY COVER

Colori disponibili

-  Avio
-  Blu
-  Grigio
-  Nero
-  Beige
-  Rosso

- **COPRISEDILI UNIVERSALI**
- **MISURA UNICA**
- **MONTAGGIO E
SMONTAGGIO RAPIDO**
- **NON INTERFERISCONO
CON AIRBAG LATERALI**

PIUMONI UNIVERSALI COMPLETO PER TRE SEDILI CON POGGIATESTA ADATTO A TUTTE LE STAGIONI

Art. LI0019



FURGONI

Colori disponibili

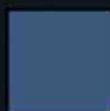

Avio



Grigio

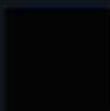

Nero

- **COPRISEDILI UNIVERSALI**
- **MISURA UNICA**
- **MONTAGGIO E SMONTAGGIO RAPIDO**
- **PREDISPOSIZIONE CINTURE DI SICUREZZA**

Schienali e Stuoie



Art. LI024



Schienale "Marinella"
paper naturale
Colore : bianco,giallo,rosa
azzurro,grigio,verde,rosso



Art. S2032



Stuoia "Rimini", paper naturale in busta.
Conf. 2 pezzi. Colore: bianco



Art. S2094



Schienale "California", bamboo naturale.
Conf. 1 pezzo in busta. Colore: blu e grigio



Art. A0660



8 030047 400299
Parasole "Plus" con ventose,
colori assortiti. Conf. 1 pezzo
in busta
 140x70

Art. A0658/C



8 008144 003446
Parasole con ventose,
colori assortiti.
Conf. 1 pezzo in busta
 130x60

Art. A0661



8 008144 006614
Parasole "Big" con ventose,
colori assortiti.
Conf. 1 pezzo in busta
 150x90

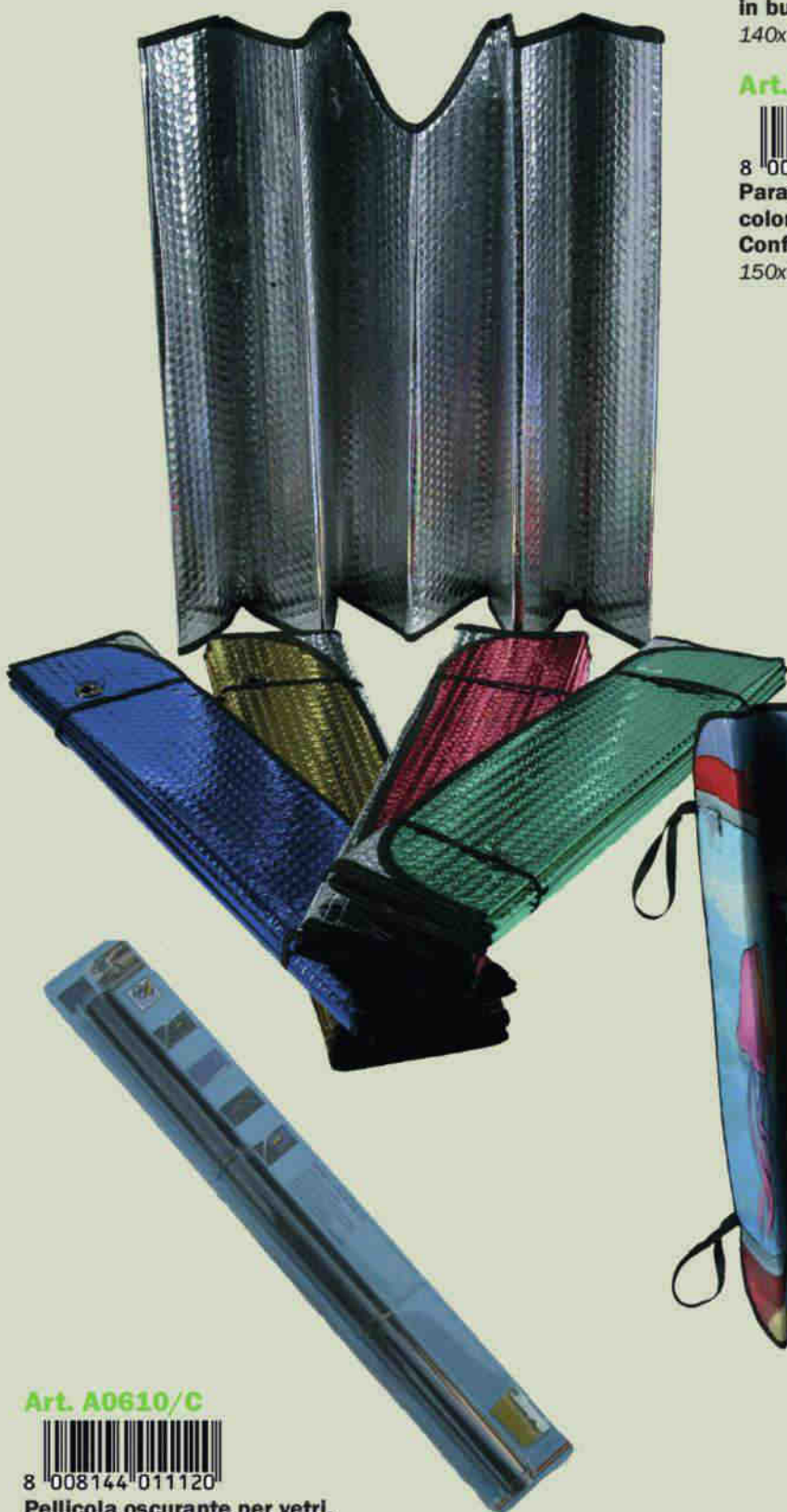

Art. A0610/C



8 008144 011120
Pellicola oscurante per vetri.
Conf. 1 pezzo in blister
 300x50

Art. A0658/D



8 008144 016958
Parasole stampato "Fantasy" con ventose.
Conf. 1 pezzo in busta
 130x60

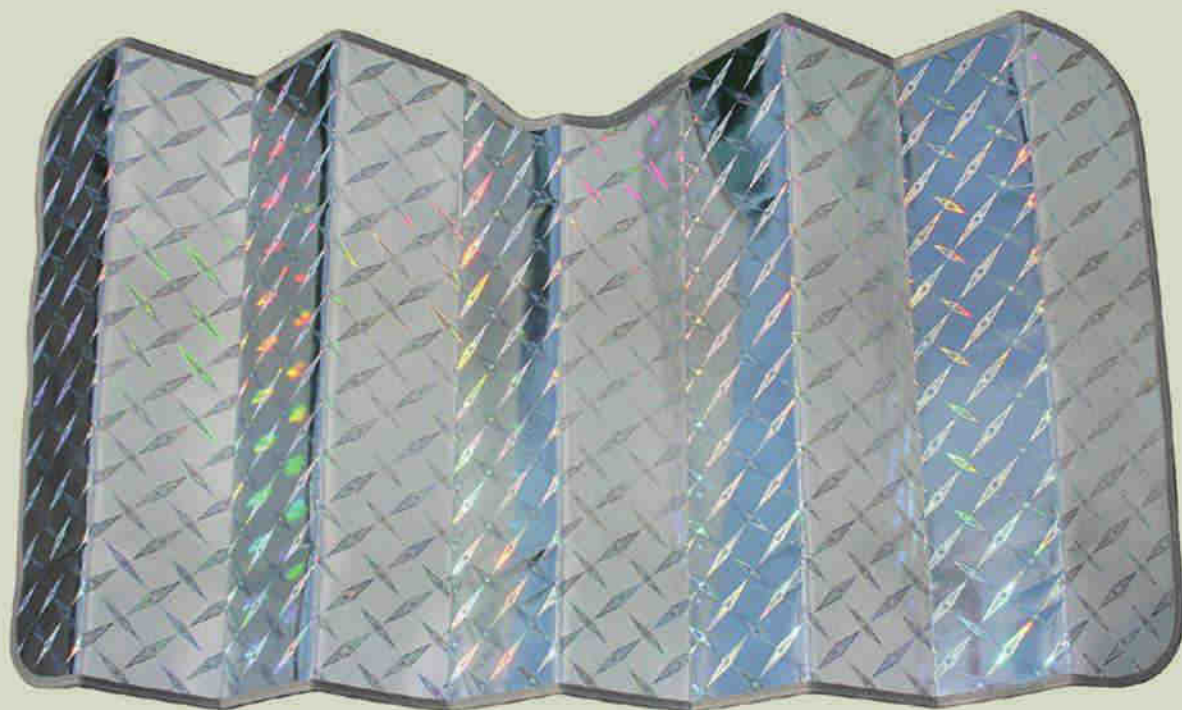

Art. kr5004

Parasole "LASER" con
ventose, rigido
Conf. 1 pezzo in busta
130 X 60

Art. kr5005

Parasole "LASER" con
ventose, rigido
Conf. 1 pezzo in busta
140 X 70

Art. kr5006

Parasole "LASER" con
ventose, rigido
Conf. 1 pezzo in busta
145 X 80



Art. EU29002



8 010898 290027

Tendina laterale elettrostatica con
disegno Banda Bassotti. Conf. 2 pezzi.
Imballo: blister



Art. EU29001



8 010898 290010

Tendina laterale elettrostatica
con disegno Paperino. Conf. 2
pezzi. Imballo: blister



Art. EU27010

Tendina parasole anteriore in "Tyvek" con anelli metallo

Art. EU27011

EU 27017



EU 27016

EU 27014



EU 2707



EU 27019



EU 2707/1



EU 27021



EU 27013





TENDINE PARASOLE PER AUTO

Eccellente protezione dal sole con riduzione della temperatura interna per donare maggiore comfort ai vostri passeggeri. Adatto anche per i vostri amici a quattro zampe.

Art. EASY05



- Utilizzabile come zanzariera per auto.
- Facile da installare, senza ventose.
- Adatto per tutti i modelli di auto.



Inserire la rete flessibile ed elastica tirandola verso il basso sulla portiera dell'auto, seguendo la curvatura.



Agganciare la rete traspirante per ottenere protezione dai raggi UV e calo interno della temperatura.



Art. A0973



8 008144 099739

Pelle in microfibra. Conf. 1 pezzo.

Imballo: sfuso

60x80 cm



PELLE NATURALE SCAMOSCIATA

Art. P 25 Small cm. 58 x 39

Art. P 30 Medium cm. 62 x 41

Art. P 35 Large cm. 67 x 44

Art. P 40 X Large cm. 73 x 48



Art. A0254/D



8 008144 010802

Pulivetro metallo con spugna.

Conf. 1 pezzo. Imballo: sfuso

22 cm

Art. A0254/A



8 008144 002548

Pulivetro metallo con spugna.

Conf. 1 pezzo. Imballo: sfuso

28 cm



Art. A0252/O



8 006324 112117

Spugna lavaggio "Ovalone".

Conf. 1 pezzo. Imballo: skinpack

GUANTO LAVAGGIO
LUSSO



8 008144 010857

Art. A0249-L



Art. A0249



8 008144 010857

GUANTO LAVAGGIO



Art. TA140186

Caratteristiche MY CAR Dainet Gold è il panno nel maxi formato **48x38** ideale per pulire e asciugare senza fatica le superfici della tua auto. Grazie al suo effetto extra grip, è ideale per parabrezza, vetri, finestrini, cruscotti, carrozzerie e parti in plastica e in metallo. Modalità d'uso Bagnare Dainet Gold prima di utilizzarlo. Al termine dell'uso lavare il panno con acqua tiepida e sapone neutro. Successivamente riporre il panno leggermente umido all'interno del comodo contenitore in dotazione.



Art. A0256



8 008144 005723
Pulivetro metallo
con retina, manico in legno.
Conf. 1 pezzo.
Imballo: sfuso
28 cm



Art. A0270/1



8 008144 022126
Spazzola di ricambio
per articolo A0270.
Conf. 1 pezzo. Imballo: sfuso

Art. A0270



8 008144 018259
Spazzolone lavaggio con manico
telescopico in alluminio + rubinetto.
Conf. 1 pezzo. Imballo: sfuso

Art. A0308



8 008144 113664

Pompa gonfiaggio a pedale con manometro,
un cilindro. Conf. 1 pezzo. Imballo: scatola



Art. A0306



8 008144 012257

Crick idraulico a cilindro 2 T.
Conf. 1 pezzo. Imballo: scatola

Art. A0306/A



8 008144 012394

Crick idraulico a cilindro 4 T.
Conf. 1 pezzo. Imballo: scatola

Art. A0306/B



8 008144 015067

Crick idraulico a cilindro 6 T.
Conf. 1 pezzo. Imballo: scatola

Art. A0305



8 008144 012264

Crick a pantografo 1 T.
Conf. 1 pezzo. Imballo: scatola

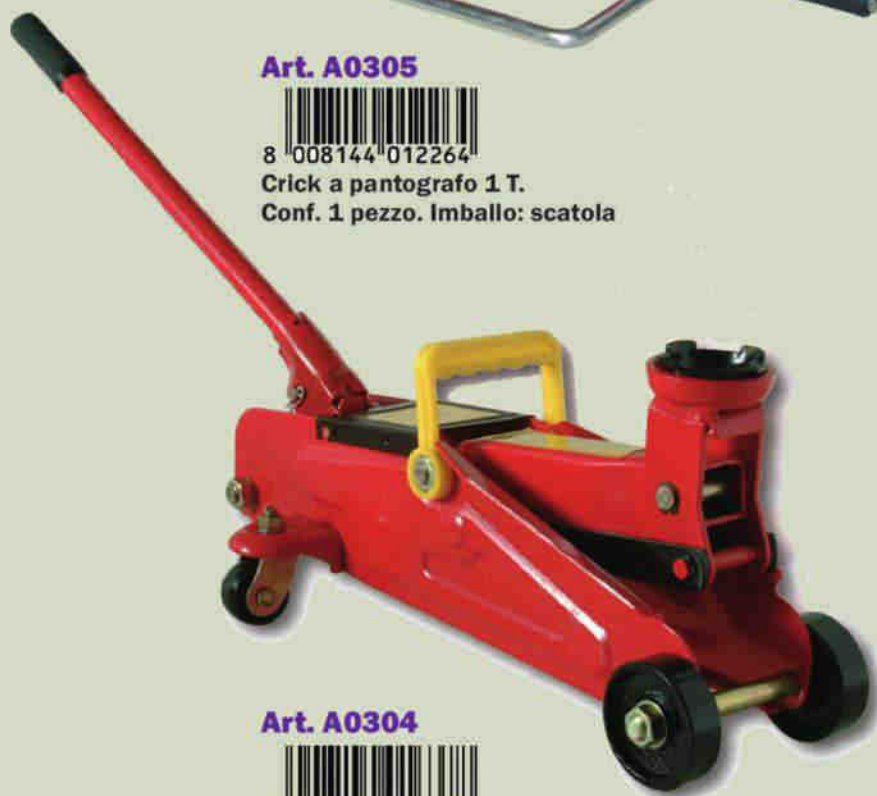

Art. A0304



8 008144 016378

Crick a carrello 2 T. Conf. 1 pezzo.
Imballo: valigetta in plastica

Emergenza e Manutenzione



Art. A0585



8 008144 019546

Compressore in metallo ad alta resa.
Conf. 1 pezzo. Imballo: scatola



Art. A0355



8 007907 001057

Busta per carburante in nylon ad alta tenuta
da 8 litri con chiusura.
Conf. 1 pezzo. Imballo: blister



Art. A0308/A



8 008144 013100

Pompa gonfiaggio a mano con manometro.
Conf. 1 pezzo. Imballo: busta

Art. A0528



8 008144 004801

Tappo benzina universale.
Conf. 1 pezzo. Imballo: sfuso appendibile



Art. A0501



8 008144 015784

Imbuto versa liquidi con prolunga flessibile.
Conf. 1 pezzo. Imballo: sfuso





Art. A0404



8 008144 010734

Set chiavi a brucola esagonali misure:
1,5/2/2,5/3/4/5/6/8/10. Conf. 9 pezzi. Imballo: blister

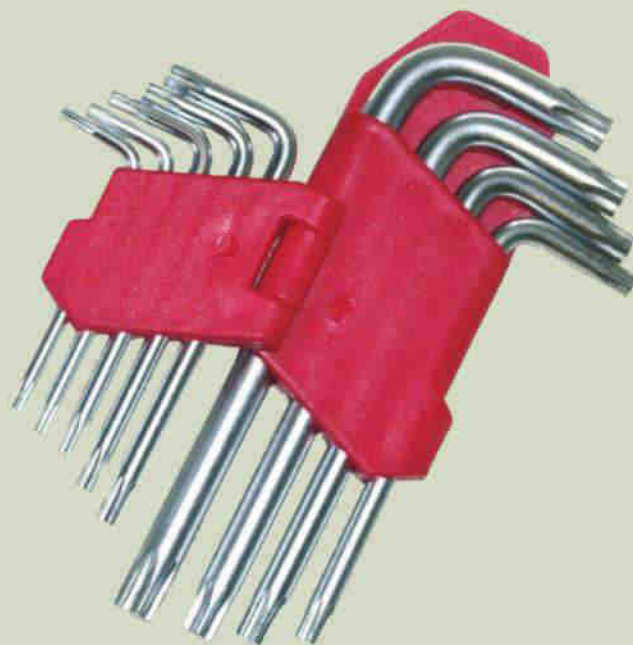

Art. A0404/A

Set chiavi a brucola Torx
misure: 1,5/2/2,5/3/4/5/6/8/10.
Conf. 9 pezzi. Imballo: blister



Art. A0401/F



8 008144 011335

Chiave candela cm 35 diametro 16 mm.
Conf. 1 pezzo. Imballo: sfuso



Art. A0414



8 009487 235884

Chiave tappo coppa olio combinata 12 mm.
Conf. 1 pezzo. Imballo: blister



Art. A0414/A



8 009487 235853

Chiave tappo coppa olio combinata 8-10 mm.
Conf. 1 pezzo. Imballo: blister



Art. A0410



8 008144 011816

Chiave a croce per vettura.
Conf. 1 pezzo. Imballo: sfuso



Art. A0415



009487 234207

Chiave filtro olio a catena.
Conf. 1 pezzo. Imballo: skinpack



Art. A0417



8 008144 000339

Chiave filtro olio a nastro.
Conf. 1 pezzo. Imballo: skinpack



Art. A0682



8 010898 116549

Tester liquido radiatore.
Conf. 1 pezzo. Imballo: blister

Art. A0699/B



8 008144 004856

Morsetti batteria positivo-negativo.
Conf. 2 pezzi. Imballo: blister



Art. A0677



8 008144 090675

Densimetro batteria.
Conf. 1 pezzo. Imballo: busta

Emergenza e Manutenzione



Art. KR56672

Cassetta pronto soccorso omologata DIN 13164



Art. BC1000

kit ripara gomme tubeless cf 1 pz doppio blister



Art. A0586



8 010898 210346

Tanica per carburante in plastica omologata da 5 litri. Conf. 1 pezzo. Colore: rosso e nero. Imballo: sfuso



Art. A0037



8 008144 000377

Triangolo "Slim" emergenza omologazione europea con supporto. Conf. 1 pezzo



Art. A0487



8 008144 010741

Tanica per carburante in plastica omologata da 10 litri. Conf. 1 pezzo. Colore: rosso e nero. Imballo: sfuso



Art. A0004



Giubbino emergenza con strisce riflettenti.
Conf. 1 pezzo. Colore: giallo e arancio. Imballo: busta



Art. A0588



Tanica per carburante in plastica omologata da 20 litri.
Conf. 1 pezzo. Colore: nero. Imballo: sfuso

**CUFFIE UNIVERSALI
PER GIUNTI OMOGINETICI**

Innoteil® -Germany-



Art. DRCU0001
cuffia coprigiunto universale



Art. DRCU0020
cuffia universale in sacch. pvc contenente 1 bustina grasso MOS2 e 2 fascette in acciaio Panduit



Art. DRCF1020
cuffia universale suv e furgoni in sacch. pvc ontenete 1 bustina di grasso MOS2 e 2 fascette in acciaio Panduit

Emergenza e Manutenzione



Art. A0005



8 024814 134142

Cartello carico-sorgente in alluminio
Conf. 1 pezzo. Imballo: pellicola



Art. A0009



8 008144 022041

Cartello carico-sorgente in plastica con gemme
rifrangenti. Conf. 1 pezzo. Imballo: sfuso



Art. UN3251

Estintore Kg. 2
Omologato Norme 3.7 ricaricabile



Art. UN3231

Estintore Kg. 1
Omologato Norme 3.7 ricaricabile

Cod. Art.	Descrizione - Materiale	Misure
F25-100N	Nylon Dupont " Zitel 101L" NERA 100 Pz.	2,5 x 100
F25-100B	Nylon Dupont " Zitel 101L" BIANCA 100 Pz.	2,5 x 100
F36-150N	Nylon Dupont " Zitel 101L" NERA 100 Pz.	3,6 x 150
F36-150B	Nylon Dupont " Zitel 101L" BIANCA 100 Pz.	3,6 x 150
F48-200N	Nylon Dupont " Zitel 101L" NERA 100 Pz.	4,8 x 200
F48-200B	Nylon Dupont " Zitel 101L" BIANCA 100 Pz.	4,8 x 200
F48-300N	Nylon Dupont " Zitel 101L" NERA 100 Pz.	4,8 x 300
F48-300B	Nylon Dupont " Zitel 101L" BIANCA 100 Pz.	4,8 x 300
F48-350N	Nylon Dupont " Zitel 101L" NERA 100 Pz.	4,8 x 350
F48-350B	Nylon Dupont " Zitel 101L" BIANCA 100 Pz.	4,8 x 350
F48-368N	Nylon Dupont " Zitel 101L" NERA 100 Pz.	4,8 x 368
F48-368B	Nylon Dupont " Zitel 101L" BIANCA 100 Pz.	4,8 x 368
F76-290N	Nylon Dupont " Zitel 101L" NERA 100 Pz.	7,6 x 290
F76-290B	Nylon Dupont " Zitel 101L" BIANCA 100 Pz.	7,6 x 290



Cod. Art.	Descrizione - Materiale	Misure
FV08-12	Fascette stringitubo a vite senza fine ACCIAIO W1 al CARBONIO 100 Pz.	08-12
FV10-16	Fascette stringitubo a vite senza fine ACCIAIO W1 al CARBONIO 100 Pz.	10-16
FV12-22	Fascette stringitubo a vite senza fine ACCIAIO W1 al CARBONIO 100 Pz.	12-22
FV16-27	Fascette stringitubo a vite senza fine ACCIAIO W1 al CARBONIO 100 Pz.	16-27
FV20-32	Fascette stringitubo a vite senza fine ACCIAIO W1 al CARBONIO 50 Pz.	20-32
FV25-40	Fascette stringitubo a vite senza fine ACCIAIO W1 al CARBONIO 50 Pz.	25-40
FV32-50	Fascette stringitubo a vite senza fine ACCIAIO W1 al CARBONIO 50 Pz.	32-50
FV40-60	Fascette stringitubo a vite senza fine ACCIAIO W1 al CARBONIO 50 Pz.	40-60
FV50-70	Fascette stringitubo a vite senza fine ACCIAIO W1 al CARBONIO 50 Pz.	50-70
FV60-80	Fascette stringitubo a vite senza fine ACCIAIO W1 al CARBONIO 50 Pz.	60-80
FV70-90	Fascette stringitubo a vite senza fine ACCIAIO W1 al CARBONIO 50 Pz.	70-90
FV80-100	Fascette stringitubo a vite senza fine ACCIAIO W1 al CARBONIO 50 Pz.	80-100



Cod. Art.	Descrizione - Materiale	Misure
FP362W5	Fascette auto bloccanti W5 AISI 316	7,9 x 362



WAG

GLOBAL PARTS



RICERCA ARTICOLI

DIGITARE : www.shopwag-italy.com

Account : botteghi0586

Password : 00807

Don't care, just drive!

Emergenza e Manutenzione

WAG

FILTRI WAG

ARIA - OLIO

CARBURANTE - ABITACOLO



PASTIGLIE FRENO WAG-TOMEX



ANTIVIBRATION SHIM (piastra antivibro):

riduce le oscillazioni e le vibrazioni del sistema frenante, impedisce rumori di cigolio durante il ciclo di vita del prodotto

BACKING PLATES (placca posteriore):

Eseguita con precisione nel pieno rispetto dei WVA e verniciata con materiale anticorrosivo

UNDERLAYER (sottostrato):

riduce le oscillazioni e le vibrazioni del sistema frenante, riduce il trasferimento del calore della frenata alla pinza, migliora il "legame" tra la mescola e la placca posteriore

FRICTION MATERIAL (mescola di attrito):

caratterizzato da un coefficiente di frizione stabilizzato per tutte le condizioni di temperatura e pressione -senza amianto - non contiene metalli "pesanti" - garantisce un ottimale rilascio di calore e usura durante la frenata

SCORCHING LAYER 1,5 mm

(strato di Scorching 1,5 mm):
lo strato più esterno del materiale di attrito è sottoposto ad un processo termico con lampade ad infrarossi che raggiungono i 1200 °C, questo processo migliora notevolmente il coefficiente di frizione. Tutto ciò è necessario per permettere alle nostre pastiglie di frenare immediatamente ed eliminare il tempo di assestamento ai dischi freno usati

TOMEX
brakes

Emergenza e Manutenzione

Le pastiglie freno Tomex sono autorizzate dalla VRI, proprietaria del sistema numerico dei WVA



TOMEX
brakes

CODICE PASTIGLIA FRENO

CODICE WVA

APPLICAZIONI

DISEGNO PASTIGLIA FRENO

SPESORE MATERIALE ATTRITO

NUMERO OMOLOGAZIONE R-90

CODICE A BARRE

10-78

WVA 20961

Audi A4 08/97 - 09/00
Audi A6 11/00 ->
Peugeot 405 10/87 - 12/91
Peugeot 907 08/02 ->
Renault Megane 09/02 ->
VW Bora, Passat 11/96 - 08/03

E4 90R-01419/061

WAG



15.20
x4



0096485101134



Lampade e Accessori
per Autoveicoli



per **vedere**
e **farsi vedere**

Per tutti i prodotti scarica il catalogo da www.robortobotteghisas.it



GORILLAS



KIT LED
di ultima generazione



LED Chip: CSP Chip
Power/Lumen: 25W 20000lm*
Input voltage: 12-24V
Water Proof: IP68
Material: Aluminum alloy
Beam Angle 360°, LED on both 2 sides*Working temperature: -45°C--105 °C*
Defective rate:<0.1%
Color: 6000K(White)

Art. KL1010

LUNA H4

coppia lampade h4 CSP led-25W-20.000lm



Driver: •Built •External•
Heat Sink: Turbo Fan•
Life-span: >50000hrs



LED Chip: CSP Chip
Power/Lumen: 25W 20000lm Input voltage: 12-24V
Water Proof: IP68
Material: Aluminum alloy
Beam Angle 360° , LED on both 2 sides
Working temperature: -45°C--105 °C
Defective rate: <0.1%
Color: 6000K(White)
Driver: Built External
Heat Sink:
Turbo Fan Life-span: >50000hrs

Art. KL1011

LUNA H7

coppia lampade h7 CSP led-25W-20.000lmm





Input Power	50W
Operating Voltage	12V - 24V
Luminous Flux	6000LM
Name	PREMIUM G7
IP Rate	IP65
Light Source Model	ZES 2 Technology
Color Temperature	6000K
Heat Dissipation Theory	+A380 Aluminium Avio
Operating Life	>30000hrs
Operating Temperature	40° / +85°

Art. KL1021

MARTE H7

coppia lampade h7 led-6000lm

FARIL NTICOLARI

 **GORILLASh** 



Art. A0121



8 008144 020153

Cavi batteria per moto pinza in metallo.
Conf. 2 pezzi in borsa Pvc.



Art. A0030/6

Ciacson auto,
1 elemento a 2 contatti.
Conf. 1 pezzo in blister
12 v



Art. A0333

Tromba auto,
2 elemento a 2 contatti.
Conf. 2 pezzi in blister
12 v



Art. A0828

Adattatore USB,
Conf. 1 pezzo in blister
12 v



Art. A0332

Tromba auto,
1 elemento a 2 contatti.
Conf. 1 pezzo in blister 12 v



Art. A0123



8 008144 010505

Cavi batteria pinza in metallo. Conf. 2 pezzi in borsa Pvc. 10x2,5 - 200 A



Art. A0803

Accendino completo
con luce. Conf. 1
pezzo in blister
12 v



8 008144 016668

CODICE - ITEM NO.	LUNGHEZZA	PINZA	mm ²
MA16250	2500 mm	120 AH	16 mm ²
MA25350	3500 mm	120 AH	25 mm ²



SENSORI DI PARCHEGGIO



Art. RP0044

**Kit completo di 4 sensori verniciabili da utilizzare su paraurti posteriori
Allarme sonoro avvicinamento
Punta speciale per trapano
Universale 12 v.**

12 V

4 SENSORI



Art. RP0094N

**Kit completo di 4 sensori verniciabili da utilizzare su paraurti posteriori
Display Led
Visualizzatore centimetri
Allarme sonoro avvicinamento
Punta speciale per trapano
Universale 12 v.**

12 V

4 SENSORI



Art. RP00440

Kit completo 4 sensori tipo originale da utilizzare su paraurti posteriore allarme sonoro avvicinamento punta speciale per trapano universale 12 v.

12 V

4 SENSORI



Art. A0488



8 008144 018051
Fusibili bilama mini
 3-5-7,5-10-15-20-25-30A
 Conf. 10 pezzi in blister



Art. A0489



8 016751 321037
Fusibili bilama standard
 5-7,5-10-15-20-25-30A
 Conf. 10 pezzi in blister



Art. A0482

Fusibili bilama extramaxi.
 20-30-40-50-60-70-80-100A
 Conf. 1 pezzo sfuso



Art. A0113

Fusibili bilama standard. 5-7,5-10-15-20-25-30A
 Conf. 50 pezzi box in pvc



Art. A0481



8 007517 115038
Fusibili a cilindro
 2-5-8-16-25A
 Conf. 10 pezzi in blister

Calamito LED cod. EL027

Torcia ad alta luminosità con gancio e magnete



Finitura esterna con "Grip Film" antiscivolo effetto gomma

30 mm
215 mm



Lumen



2,5 ore
Autonomia



Distanza



Lumen



6 ore
Autonomia



Distanza

Caratteristiche tecniche

Grado di protezione: IPX4 - Protetto da spruzzi d'acqua

Alimentazione: 4 batterie AAA Duracell (incluse)

Illuminazione: LED COB + LED 1 Watt

Luminosità: LED COB 200 lumen
LED 1 W 60 lumen

Autonomia: LED COB 2,5 ore
LED 1 W 6 ore

Portata luce: LED COB 20 m
LED 1 W 50 m

Magnete posteriore

Gancio per affissione

Materiale: ABS con finitura esterna: "grip film" antiscivolo effetto gomma

Funzioni

ON/OFF

Luce centrale / Luce alta

Confezione

Espositore da 12 pz

Imballo: 24 pz

U.V. 12 pz

Gancio di affissione ruotante



Magnete per superfici metalliche



Doppia possibilità di affissione:

- con gancio a scomparsa
- con magnete

**IDEALE
PER LAVORI
A MANO
LIBERA**



Calamito Large cod. EL028

Torcia ad alta luminosità con gancio e magnete



35 mm
195 mm



Caratteristiche tecniche

Grado di protezione:	IPX4 - Protetto da spruzzi d'acqua
Alimentazione:	3 batterie AA Duracell (incluse)
Illuminazione:	LED COB
Luminosità:	200 lumen
Autonomia:	4,5 ore
Portata luce:	20 m
Magnete posteriore	
Gancio per affissione	
Materiale:	ABS con finitura esterna: "grip film" antiscivolo effetto gomma

Funzioni

ON/OFF

Confezione

Espositore da 12 pz	
Imballo:	24 pz
U.V.	12 pz



Doppia possibilità di affissione:

- con gancio a scomparsa
- con magnete



Calamito Power cod. EL056

Torcia ricaricabile ad alta luminosità con gancio e magnete



3 livelli di illuminazione:

luce alta intensità
luce media intensità
luce concentrata

IDEALE
PER LAVORI
A MANO
LIBERA

Doppia possibilità di affissione:

- con gancio a scomparsa
- con magnete



Base inclinabile con magnete e gancio sul retro



Blister con asola e cavo di ricarica USB sul retro



Lumen



Autonomia



Distanza



Lumen



Autonomia



Distanza

Caratteristiche tecniche

Grado di protezione:	IP44 - Protetto da corpi solidi superiori a 1 mm di diametro e protetto contro gli spruzzi di acqua da tutte le direzioni
Alimentazione:	batteria Li-Ion 3.7V 3000 mAh ricaricabile
Illuminazione:	LED COB + 1 LED SMD 3W
Luminosità:	LED COB 250 lumen LED SMD 120 lumen
Autonomia:	LED COB 3,5 ore LED SMD 8 ore
Portata luce:	LED COB 30 m LED SMD 20 m
Input ricarica:	USB 5V $\overline{\text{---}}$ 1A
Tempo di ricarica:	3,5 ore
Dotazioni:	Magnete posteriore Base reclinabile Gancio a scomparsa Cavo di ricarica USB
Materiale:	ABS in gomma morbida

Funzioni

- ON/OFF
- Luce centrale alta intensità e media intensità
- Luce concentrata sulla parte alta della torcia

Confezione

Espositore da 6 pz	
Imballo:	24 pz
U.V.	6 pz



Extreme LED 10W cod. EL041

Torcia 1 LED da 10 Watt ricaricabile



Caratteristiche tecniche

Grado di protezione: IP44 - Protetto da corpi solidi superiori a 1 mm di diametro e protetto contro gli spruzzi d'acqua da tutte le direzioni

Batteria: piombo-acido 4V - 4 Ah ricaricabile ed estraibile

Caricabatterie: Input 230V - 50 Hz
Output 6V --- 300 mA

Caricabatterie Auto: Input 12V / Output 12V

Illuminazione: 1 LED CREE - 10 Watt

Luminosità: 800 lumen

Autonomia: 8 ore

Tempo di ricarica: 8/10 ore

Caricabatterie: 220V da rete e 12V da auto (inclusi)

Cinghia a tracolla inclusa

Materiale: ABS / Polietilene alta densità



Batteria di ricambio ermetica
4 V - 4 Ah ricaricabile.
Cod. E018R



Disponibile:

KIT di ricambio contenente 2 caricabatterie (220V e 12V) per EL041 ed E018: cod. EL042

Funzioni

ON/OFF - Funzione luce di emergenza

LED controllo ricarica

2 Caricabatterie: 220 V e 12 V





Mr LIGHT

LE TORCE PORTATILI RICARICABILI
DAL DESIGN COMPATTO
FACILI DA TRASPORTARE
ESTREMAMENTE VERSATILI

torce ricaricabili

IDEALI PER

casa

ufficio

officina

automobile

campeggio

hobbistica



BSG99

Pratica torcia con cavalletto orientabile. Questo modello permette di visualizzare il livello di carica della batteria tramite un comodo display.



Presse mini USB per ricarica



Livello carica batteria



LED Frontale



Staffa magnetica orientabile di 180°



Gancio estraibile

Materiale	TPR	Durata	circa 2.5 - 3 ore
Dimensioni	155x40x20 mm	Lampadina	3W LED + 3 COB LED
Peso	131.8 g	Potenza	batteria ricaricabile
Carica	circa 25 ore	Batteria	3.7V - 1x18650 Li-ion 1200mAh inclusa

GORILLAS Mr LIGHT

BSG106

Non solo una torcia! Il modello più completo della serie Mr Light, oltre ad avere un potente fascio luminoso dimmerabile; può, in caso di emergenza, essere utilizzato come power bank per ricaricare il proprio smartphone.



Funzione POWER BANK



Dotato di uscita USB per ricaricare il cellulare.



180°
Gancio e base magnetica



Inclinazione della luce regolabile fino a 270°



Tasto ON/OFF
premere a lungo l'interruttore per diminuire la luminosità



premi 1 volta: luce in alto
premi 2 volte: luce laterale



premere a lungo l'interruttore per aumentare la luminosità

BSG107

Versione in piccolo della BSG106, spicca per maneggevolezza e praticità.



La staffa può essere ruotata di 270°



Presse USB per ricarica



Livello carica batteria



180°
Gancio e base magnetica



Tasto ON/OFF

Materiale	PC+TPR+Alluminio		Luce di testa	Luce laterale
Dimensioni	150x48x39 mm (piegata) 275x48x39 mm (aperta)	Lampadina	2x3W LED	5W COB LED
Peso	213.5 g	Tempo	4-4.5 ore	3-3.5 ore
Carica	4 ore	Luminosità	240LM	380-400LM
Batteria	3.7V - 1 pc 18650 Li-ion 2000MAH	Ingresso	MICRO USB	

Nome	Torcia portatile ricaricabile	Durata	4.5 ore (luce di testa) 3 (luce laterale)
Materiale	PA+TPR+Alluminio	Luminosità	150 (luce di testa) 360 (luce laterale)
Dimensioni	150x48x39 mm (piegata) 270x48x39 mm (aperta)	Batteria	3.7V 2000mAh 18650 Li-ion
Peso	157 g	Ingresso	MICRO USB
Carica	4 ore		



DURACELL PLUS POWER



Denominazione e descrizione articolo	codice	barcode	confezione	contenuto	UV
DURALOCK PLUS POWER Stilo (AA) 1500	DU0100	5000394017641	blister	4 pile/blister	20
DURALOCK PLUS POWER Ministilo (AAA) 2400	DU0200	5000394018457	blister	4 pile/blister	10
DURACELL PLUS POWER Mezzatorcia (C), blister rosso 1400	DU0300	5000394019089	blister	2 pile/blister	10
DURACELL PLUS POWER Torcia (D), blister viola 1300	DU0400	5000394019171	blister	2 pile/blister	10
DURACELL PLUS POWER Transistor (9V), blister	DU0501	5000394105485	blister	1 pila/blister	10
DURACELL PLUS POWER Piatta (4,5V), blister bianco 1203	DU0600	5000394019317	blister	1 pila/blister	10



DURACELL SICUREZZA



Denominazione e descrizione articolo	codice	barcode	confezione	contenuto	UV
DURACELL N (MN9100) 1,5 Volt apri cancello / macchina	DU26	5000394203983	blister	2 pile/blister	10
DURACELL MN2500 AAAA	DU57	5000394041660	blister	2 pile/blister	10
DURACELL MN11	DU59	5000394015142	blister	1 pila /blister	10
DURACELL MN21 12 Volt, apri cancello / macchina	DU25	5000394203969	blister	2 pile/blister	10
DURACELL MN27	DU58	5000394023352	blister	1 pila /blister	10



DURACELL ELETTRONICA



Denominazione e descrizione articolo	codice	barcode	confezione	contenuto	UV
DURACELL 1220 ELETTRONICA	DU30	5000394030305	blister	1 pila /blister	10
DURACELL 1616 ELETTRONICA	DU48	5000394030336	blister	1 pila /blister	10
DURACELL 1620 ELETTRONICA	DU27	5000394030367	blister	1 pila /blister	10
DURACELL 2016 ELETTRONICA	DU20B2	5000394203884	blister	2 pile /blister	10
DURACELL 2025 ELETTRONICA	DU21	5000394033979	blister	1 pila/blister	10
DURACELL 2032 ELETTRONICA	DU22	5000394033917	blister	1 pila/blister	10
DURACELL 2430 ELETTRONICA	DU49	5000394030398	blister	1 pila /blister	10
DURACELL 2450 ELETTRONICA	DU31	5000394030428	blister	1 pila /blister	10

► SCHEMA FASI DI CARICA E MANTENIMENTO

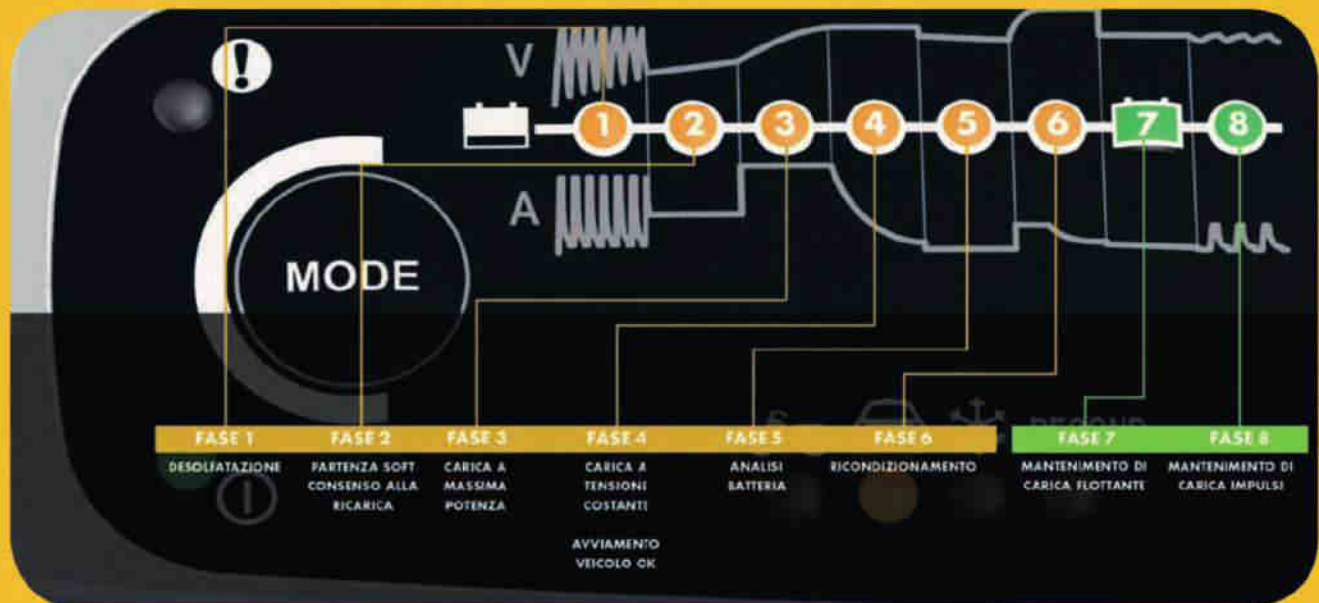

Questo schema illustra tutte le Fasi di Carica e Mantenimento che sono adottate dai caricabatterie CTEK del presente catalogo nelle loro varie versioni. La batteria è generalmente carica a sufficienza per l'avviamento all'accensione della spia 4, mentre la spia verde 7 indica batteria carica al 100% ed in Mantenimento. La spia verde 8 si accende dopo circa 10 giorni di assoluto riposo della batteria, ed indica il Mantenimento di lungo periodo. Sui modelli XCQ.8, XS3.3, LITHIUM XS, MXS7.0, M45, M100, M200, M300 e sulla serie DC-DC le fasi di carica sono indicate con un'altra simbologia, fare riferimento ai singoli Manuali d'istruzione.

► PERCHÈ PRENDERSI CURA DELLE BATTERIE

Questi sono i principali problemi cui va incontro una batteria al piombo/acido in assenza di una corretta ricarica.

SOLFATAZIONE:
Quando la batteria si scarica, il solfato di piombo tende ad aggregarsi in cristalli. Se la batteria non viene ricaricata al più presto, si formano i cristalli al suo interno e la batteria perde capacità.

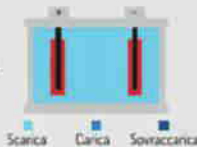

Se la batteria non viene desolfatata i cristalli di solfato di piombo si aggregano e si consolidano sulle piastre. La batteria perde progressivamente e irreversibilmente la sua capacità, e spesso deve essere sostituita anzitempo.

FASE 1



Il programma di Desolfatazione di CTEK è in grado di dissolvere i cristalli di solfato di piombo accumulati sulle piastre. La batteria riacquista rapidamente in parte o per intero la capacità perduta.

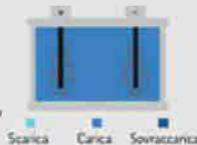

STRATIFICAZIONE:
Quando una normale batteria al piombo viene frequentemente scaricata intorno al 50%, l'acido al suo interno inizia a stratificare. Questo significa che l'acido solforico e l'acqua formano due strati separati. La vita utile e la capacità della batteria diminuiscono drammaticamente.



La fase di ricondizionamento nei caricabatterie CTEK è studiata per eliminare questo problema: la batteria riacquista capacità e tempo di esercizio.

FASE 6



La funzione RECOND di CTEK ha la capacità di rimoscolare l'acido e di "equalizzare" la sua densità nella batteria. Una densità uniforme significa una ricarica più completa e una batteria più "fresca", con una vita operativa nettamente più lunga.



ESSICCAZIONE:
Se la batteria viene ricaricata ad un voltaggio troppo elevato, la carica eccessiva porta ad una rapida evaporazione dell'acqua. La parte superiore delle piastre si scopre e viene danneggiata permanentemente.



Se si usa un caricabatteria di tecnologia superata o non intelligente il sovravoltaggio è altamente probabile, e l'essiccazione danneggerà la vostra batteria.

IL CONTROLLO DI CARICA CTEK

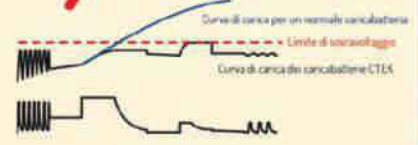

5
ANNI
GARANZIA



XC 0.8 (6V)

• Totalmente automatico

4 Fasi: Desolfatazione – Corrente costante – Tensione costante – **Mantenimento ad impulsi di lungo periodo.**

Protezione da scintille, corto circuito, inversione di polarità e temperatura eccessiva. Ideale per moto e vetture d'epoca.



Corrente di Carica	0,8A (10W)
Tensione di Carica	7,2V
Capacità Batterie	1,2 – 60Ah (100Ah Mantenimento)
Fasi e Programmi	4 fasi, Automatico
Dimensione e Peso	142x51x36mm – 0,3Kg

5
ANNI
GARANZIA



XS 0.8 (12V)

• Totalmente automatico

6 fasi: Desolfatazione – Corrente costante – Tensione costante – Analisi – Mantenimento flottante – **Mantenimento ad impulsi di lungo periodo.**

Protezione da scintille, corto circuito, inversione di polarità e temperatura eccessiva. Ideale per moto, moto da neve e da acqua, vetture piccole e medie



Corrente di Carica	0,8A (10W)
Tensione di Carica	14,4V
Capacità Batterie	1,2 - 32Ah (100Ah Mantenimento)
Fasi e Programmi	6 fasi, Automatico
Dimensione e Peso	142x51x36mm – 0,3Kg

5
ANNI
GARANZIA



MXS 3.6 (12V)

Programmi: Moto (0,8A/14,4V), Auto (3,6A/14,4V), AGM (3,6A/14,7V)

7 fasi: Desolfatazione – Corrente costante – Tensione costante – **Mantenimento ad impulsi di lungo periodo.**

Protezione da scintille, corto circuito, inversione di polarità e temperatura eccessiva.

Ideale per moto, auto di media cilindrata, piccole imbarcazioni



Corrente di Carica	0,8 – 3,6A (45W)
Tensione di Carica	14,4V – 14,7V
Capacità Batterie	1,2 – 5 Ah (100Ah Mantenimento)
Fasi e Programmi	7 fasi, 3 Programmi
Dimensione e Peso	165x61x38mm – 0,5Kg



START/STOP

Il caricabatteria START/STOP è stato sviluppato per l'utilizzo sui veicoli dotati delle speciali batterie in grado di sopportare questo gravoso impegno. Non ci sono pulsanti e non è necessario effettuare alcuna scelta. START/STOP di CTEK si prende cura della vostra batteria EFB o AGM in modo completamente automatico, è sufficiente connetterlo.



TIME TO GO

TIME TO GO risponde a due importanti domande: "quando posso provare ad avviare il mio veicolo?" e "quanto ci vorrà per ricaricare a fondo la mia batteria?".

TIME TO GO dispone dei programmi per batterie standard e AGM, e per il Ricondizionamento.



POWERSPORT

Un nuovo caricabatteria progettato per tutti i veicoli sportivi, dai motocicli ai quad, dalle motoslitte alle moto d'acqua.

La speciale funzione CANBUS in abbinamento al connettore Accendisigari 40-165 (a richiesta), è dedicata alle moto BMW dotate di questa tecnologia.



CARATTERISTICHE	START/STOP	TIME TO GO	POWERSPORT
ALIMENTAZIONE	220-240VAC,	220-240VAC,	220-240VAC,
CORRENTE DI	50-60Hz 3.8A	50-60Hz 5.0A (60W)	50-60Hz 2.3A (28W)
CARICA TENSIONE	(46W) 14,55V	14,4 / 14,7 / 15,8V 8	14,4 / 14,7 / 15,8V 8
DI CARICA FASI	8 Fasi	Fasi	Fasi
PROGRAMMI	Automatico	3 Programmi	3 Programmi
CAPACITÀ	1.4 - 130Ah	20-160Ah 165x61x38	5-25Ah
BATTERIE	165x61x38 mm	mm	165x61x38 mm
DIMENSIONI PESO	0,5 Kg	0,5 Kg	0,5 Kg



"MIGLIORE DEL TEST" SULLA PRESTIGIOSA RIVISTA TEDESCA AUTOBILD

5 ANNI
GARANZIA



12V
WET MF
AGM GEL
Ca/Ca
IP65

MXS 5.0 (12V)

Programmi: Moto (0,8A/14,4V), Auto (5A/14,4V), AGM (5A/14,7V), Recond (1,5A/15,8V)
8 Fasi: Desolfatazione – Soft Start – Corrente costante, Tensione costante – Analisi – Recond – Mantenimento flottante – **Mantenimento ad impulsi di lungo periodo.**
 Protezione da scintille, corto circuito, inversione di polarità e temperatura eccessiva.
 Ideale per moto, tutti i tipi di vettura, furgoni, piccole imbarcazioni, trattori, campers



Corrente di Carica	0,8A – 5A (70W)
Tensione di Carica	14,4V – 14,7V – 15,8V
Capacità Batterie	1,2 – 110Ah (160Ah Mantenimento)
Fasi e Programmi	8 fasi, 4 Programmi
Dimensione e Peso	168x65x38mm – 0,6Kg

5 ANNI
GARANZIA



12V
WET MF
AGM GEL
Ca/Ca
IP65

MXS 5.0 CHECK (12V)

Programmi: 4 per moto a 0,8A e 4 per auto a 5,0A (Standard a 14,4V con e senza Recond a 15,8V - AGM/Freddo a 14,7V con e senza Recond a 15,8V).
Fasi, Applicazioni e Protezioni: Come MXS 5.0
Programma CHECK: Premendo il tasto Mode per qualche secondo il Caricabatteria entra in Modalità "CHECK". Vengono eseguiti in sequenza i test di Stato di Carica, Capacità di Avviamento, Alternatore.
 I risultati vengono indicati in modo rapido ed intuitivo, per una valutazione semplificata dello stato della batteria.



Corrente di Carica	0,8A – 5A (70W)
Tensione di Carica	14,4V – 14,7V – 15,8V
Capacità Batterie	1,2 – 110Ah (160Ah Mantenimento)
Fasi e Programmi	8 fasi, 8 Programmi
Dimensione e Peso	168x65x38mm – 0,6Kg



■ MXS 7.0 (12V)

Programmi: Normale (7A/14,4V), AGM (7A/14,7V), Supply (7A/13,6V), Recond (1,5A/15,8V)

8 Fasi: Desolfatazione – Soft Start – Corrente costante – Tensione costante – Analisi – Recond – Mantenimento flottante – **Mantenimento ad impulsi di lungo periodo.**

Protezione da scintille, corto circuito, inversione di polarità e temperatura eccessiva. Ideale per tutti i tipi di vettura, furgoni, piccole e medie imbarcazioni, trattori, campers.

Uso professionale.



Corrente di Carica	7A (100W)
Tensione di Carica	14,4V – 14,7V – 13,6V – 15,8V
Capacità Batterie	14 – 150Ah (225Ah Mantenimento)
Fasi e Programmi	8 fasi, 4 Programmi
Dimensione e Peso	191x89x48mm – 0,8Kg



■ MXS 10 (12V)

Programmi: Auto (10A/14,4V), AGM (10A/14,7V), Recond (1,5A/15,8V), Supply (10A/13,6V)

8 Fasi: Desolfatazione – Soft Start – Corrente costante – Tensione costante – Analisi – Recond – Mantenimento flottante – **Mantenimento ad impulsi di lungo periodo.**

Sensore di temperatura per il controllo del voltaggio nella fase finale della ricarica. Protezione da scintille, corto circuito, inversione di polarità e temperatura eccessiva.

Ideale per tutti i tipi di vettura, furgoni, piccole e medie imbarcazioni,



Corrente di Carica	10A (140W)
Tensione di Carica	14,4V – 14,7V – 15,8V – 13,6V
Capacità Batterie	20 – 200Ah (300Ah Mantenimento)
Fasi e Programmi	8 fasi, 4 Programmi
Dimensione e Peso	200x90x50mm – 0,9Kg

Elementi Elettrici



Connect Ready and go

FEATURES

- Jump Starter
- Power Bank
- Lighting
- S.O.S
- Strobe

12V Jump Start Socket

Power Button

Battery Indicator Lights

Type C Input

QC18W USB Output

USB 5V 2.4A Output

LED light

Art. KRS601 - Avviatore con funzione power bank da 14000mAh



SMART JUMP STARTER

1500A peak current diesel and steam double start

One hit, no damage to the car, suitable for a variety of models

Product Configuration II

Product Configuration

Smart Version

1683 metal frame

Smart Clip

Instruction manual

Type-C charging cable

Storage bag

Packaging Box

Art. KR603 - Avviatore con funzione power bank da 16800mAh



Wireless Charging 15W Output

LED FLASHLIGHT

Great for indoors, camping emergencies etc

Household

Emergency

Night

Rescue

EPS

Art. KR606 - Jump starter 12V+wireless charging

Jump Starter 16800mAh Portable Power Bank 15W caricabatterie Wireless dispositivo di avviamento della batteria esterna dispositivo di avviamento della batteria dell'auto

Elementi Elettrici

TECNOLOGIA ESCLUSIVA



Potenti batterie al Litio, sicure al 100% e di lunghissima durata



Cavi con sistema di sicurezza e funzione BOOST*

(* Per avviamenti in assenza di batteria o batterie molto scariche)



Utilizzabili per ricaricare velocemente dispositivi elettronici via USB



Lampada LED integrata con luce fissa, lampeggiante e SOS



RoHS



Edizione 23.03

i-starter



12V

LiPo

i-starter 2.4



Compatto e leggero

Batteria	Litio-Polimero (LiPo)
Capacità batteria	10.000 mAh (37 Wh)
Ampere di avviamento	500A
Ampere di picco	1500A
Caricatore 230V	No
Dimensioni	164x86x33 mm
Peso	350 gr

12V

LiPo

i-starter 3.6



PD30W: In/Out USB Type-C che può fornire fino a 30W

Batteria	Litio-Polimero (LiPo)
Capacità batteria	16.000 mAh (59.2Wh)
Ampere di avviamento	700A
Ampere di picco	2100A
Caricatore 230V	Ultrarapido QC3.0
Dimensioni	244x108x32 mm
Peso	745 gr

i-starter 2.9



PD30W: In/Out USB Type-C che può fornire fino a 30W

Batteria	Litio-Polimero (LiPo)
Capacità batteria	12.000 mAh (44.4 Wh)
Ampere di avviamento	500A
Ampere di picco	1500A
Caricatore 230V	SI
Dimensioni	186x98x37 mm
Peso	590 gr

i-starter 4.0



Rivestimento soft-touch antiscivolo e antigraffio

Batteria	Litio-Polimero (LiPo)
Capacità batteria	18.000 mAh (66.6Wh)
Ampere di avviamento	800A
Ampere di picco	2400A
Caricatore 230V	SI
Dimensioni	274x165x60 mm
Peso	1250 gr



SG2200

12V

La sua potente batteria da 20Ah è in grado di erogare ben 2.200A di picco, pari a circa 750A di Avviamento. SG2200 è in grado di avviare ripetutamente mezzi di media cilindrata, e di mettere in moto vetture fino a 3.000cc benzina e 2.500cc gasolio. Le pinze isolate e dotate di treccia di collegamento assicurano ottima presa sui poli batteria, necessaria a far passare l'elevata corrente di spunto. Oltre alle dotazioni già descritte sul modello Dotato di lampada pivotante con protezione anti-scaricamento, voltmetro analogico, presa di corrente a 12V e presa di corrente USB per mettere sotto carica i vostri apparecchi elettronici.



CARATTERISTICHE	SG2200
BATTERIA	Piombo
CORRENTE DI SPUNTO	2200A
LUNGHEZZA CAVI	1,05 mt
SEZIONI CAVI	25 mm ²
DIMENSIONI	360x290x120 mm
PESO	9 Kg

12V

LiFePO₄

i-starter 6.0



Presa 12V accendisigari con funzione salva memoria

■ AVVIATORE D'EMERGENZA

Per ogni vettura e veicolo commerciale 12V.

■ BATTERIA PORTATILE

Uscite USB 5V 2.1A e Quick Charge 3.0 per tutti i dispositivi elettronici con batterie ricaricabili (smartphone, tablet, macchine fotografiche, Go-Pro, etc).

Batteria	Litio-Ferro-Fosfato (LiFePO ₄)
Capacità batteria	31.000 mAh (99.2Wh)
Ampere di avviamento	1200A
Ampere di picco	3600A
Caricatore 230V	Ultrarapido QC3.0
Dimensioni	266x239x119 mm
Peso	2.7 Kg

12/24V

LiFePO₄

i-starter X



Presa 12V accendisigari con funzione salva memoria

■ AVVIATORE D'EMERGENZA

Per ogni vettura e veicolo commerciale 12V.
Avvio saltuario di veicoli industriali 24V

■ BATTERIA PORTATILE

Uscite USB 5V-1/2A per tutti i dispositivi elettronici con batterie ricaricabili (smartphone, tablet, macchine fotografiche, Go-Pro, etc).

Batteria	Litio-Ferro-Fosfato (LiFePO ₄)
Capacità batteria	35.000 mAh (112Wh)
Ampere di avviamento	12V 1200A; 24V 600A
Ampere di picco	12V 3600A; 24V 1800A
Caricatore 230V	SI
Dimensioni	292x233x79 mm
Peso	2.7 Kg

ACCESSORI

intec

COMFORT INDICATOR-12V

Dall'esperienza **CTEK** nel campo delle batterie nasce un'altro innovativo articolo, il Comfort Indicator, una versione evoluta del Comfort Connector di cui sono dotati i modelli 0.8, 3.6, 5.0, 7.0, e 10. Grazie ad un'accurata misura del voltaggio, indica in tempo reale lo stato di carica della batteria tramite una serie di led colorati: Verde per batteria carica, Arancio per batteria che comincia a scaricarsi (ricaricare appena possibile), Rosso per batteria gravemente scarica (ricaricare con urgenza onde evitare danni da solfatazione). Dotato di fusibile di sicurezza, è disponibile nelle versioni con occhielli terminali, con pinze isolate o con supporto da plancia.



Comfort Indicator OCCHIELLI
L= 0,55 m

	M 6	6,4 mm	56-629
	M 8	8,4 mm	56-382



Comfort Indicator PINZE

	L	1,0 m	56-384
--	---	-------	--------



Comfort Indicator PANNELLO
con terminali M8

	L	1,5 m	56-380
	L	3,3 m	56-531

ACCESSORI CON COMFORT CONNECT

Sono inoltre disponibili set di cavi senza Indicatore per poter equipaggiare più vetture con il Comfort Connect o per connettersi tramite la presa accendisigari.



Comfort Connect OCCHIELLI
L= 0,4 m



Comfort Connect
Spina Accendisigari
Ø 12 mm/21mm

	M 6	6,4 mm	56-260
	M 8	8,4 mm	56-261
	M 10	10,5 mm	56-329

	L	0,4 m	56-263
Non utilizzabile su MXS10			

Comfort Connect
Presa Accendisigari
Ø 21 mm

	L	1,0 m	56-573
--	---	-------	--------



NEW



OBD-L

Tutta la gamma di avviatori al piombo 12V e 12/24V è compatibile con l'utilizzo del dispositivo salvamemorie OBD-L.

CARATTERISTICHE	5G2200	PB11812
CORRENTE DI SPUNTO	2200A	1600A
LUNGHEZZA CAVI	1,05 mt	71 cm
SEZIONI CAVI	25 mm ²	25 mm ²
DIMENSIONI	360 x 290 x 120 mm	278 x 95 x 317 mm
PESO	9Kg	722 Kg

Linea AGM acido a corredo



AGM acid supplied Line

- Batterie di varie tipologie: Sia pronte all'uso, che con fialetta di acido a corredo a seconda del modello
- Eccellenti prestazioni in ogni condizione climatica
- Multiple options for filling (bottle, use ready)
- Excellent performance in each climatic condition

CODICE / CODE	Tensione Voltage	Capacità Capacity	DIMENSIONE / DIMENSION			DETTAGLI / DETAILS	
	V	Ah/10h	L	W	H	FIGURA / FIGURE	Q.TÀ PER SCATOLA
CBTX12-BS	12	10	150	87	130	+ -	6
CBTX14-BS	12	12	150	87	145	+ -	6
CBTX14L-BS	12	12	150	87	145	- +	4
CBTX16-BS	12	14	150	87	161	+ -	4
CBTX20-BS	12	18	175	87	155	+ -	4
CBTX20L-BS	12	18	175	87	155	- +	4
CBTX4L-BS	12	3	114	71	86	- +	8
CBTX5L-BS	12	4	114	71	106	- +	8
CBTX7A-BS	12	6	150	87	94	+ -	6
CBTX7L-BS	12	6	114	71	131	+ -	8
CBTX9-BS	12	8	150	87	105	+ -	6
CT12A-BS	12	9,5	150	87	105	+ -	6
CT12B-BS	12	12	151	70	130	+ -	6
CT9B-BS	12	8	150	70	105	+ -	6
CTZ10S-BS	12	8,6	150	87	93	+ -	6
CTZ12S-BS	12	11,2	150	87	110	+ -	6
CTZ14S-BS	12	11,2	150	87	110	+ -	6
CTZ7S-BS	12	6	113	70	105	- +	8
CTR4A-BS	12	2,3	114	49	86	+ -	8
CT4B-BS	12	2,3	113	38	85,5	+ -	8
CBTX30L-BS	12	28	166	126	175	- +	2
U1R-9AGM	12	24	196	130	156	- +	2
U1L-9AGM	12	24	196	130	156	+ -	2
12N20AH-BS	12	20	181	76	167	- +	3
12N20AH-SM	12	20	181	76	167	- +	3
CT14B-4	12	14	152	70	145	+ -	6 Fornita carica / Loaded
CT7B-4	12	7	150	65	93	+ -	6 Fornita carica / Loaded



Linea STANDARD acido a corredo

Standard acid supplied Line

• Eccellenti prestazioni anche in condizioni climatiche estreme

• Excellent on several weather conditions

Acido a corredo / Acid supplied

CODICE / CODE	Tensione Voltage	Capacità Capacity	DIMENSIONE / DIMENSION			DETTAGLI / DETAILS	
	V	Ah/10h	L	W	H	FIGURA / FIGURE	Q.TÀ PER SCATOLA
CB10L-A2	12	11	135	90	145	- +	6
CB10L-B	12	11	135	90	145	- +	6
CB10L-B2	12	11	135	90	145	- +	3
CB12A-A	12	12	134	80	160	- +	6
CB12A-B	12	12	134	80	160	- +	6
CB12AL-A	12	12	134	80	160	- +	6
CB14-A2	12	14	134	89	166	- +	6
CB14L-A2	12	14	134	89	166	- +	6
CB14L-B2	12	14	134	89	166	- +	6
CB16AL-A2	12	16	207	71,5	164	- +	3
CB18L-A	12	18	182	92	164	- +	3
CB4L-B	12	4	120	70	92	- +	8
CB5L-B	12	5	120	60	130	- +	8
CB7-A	12	8	135	75	133	+ -	6
CB7L-B	12	8	135	75	133	- +	6
CB7L-B2	12	8	135	75	133	- +	6
CB9-B	12	9	135	75	139	+ -	6
CB9A-A	12	9	135	75	155	+ -	6
CB9L-A2	12	9	135	75	139	- +	6
CB30L-B	12	30	168	132	176	- +	2
12N5.5-3B	12	5,5	135	60	130	- +	8
C60N24L-A	12	28	184	124	170	- +	2
12N24-4	12	24	184	124	160	+ -	2
C60N30L-A	12	30	186	130	171	- +	2
C60N30A	12	30	186	130	171	+ -	2
C60N35LA-HD	15	35	238	131	167	- +	2
CTX9A-BS	12	9	135	75	139	+ -	6
CP18-12 (BMW)	12	18	181	76	167	- +	4
CB3L-A	12	3	98	56	110	- +	8
CB3L-B	12	3	98	56	110	- +	8
12N5-3B	12	5	120	60	130	- +	8
12N5.5-4A	12	5,5	135	60	130	+ -	8
12N5.5-4B	12	5,5	135	60	130	+ -	8
12N5.5A-3B	12	5,5	103	90	114	- +	8
CB7A-A	12	8	135	75	148	+ -	8
CB7C-A	12	8	130	90	114	- +	6
CB9L-B	12	9	135	75	139	- +	6
CB18-A	12	18	180	90	162	+ -	4
C50N18L-A2	12	20	206	91	164	- +	1
CBTX20CH-BS	12	18	150	87	155	+ -	1

gamma

YR
SUPREME LONG LIFE
 AUTO / VL - VEICOLI COMMERCIALI

Codice	Référence	Code	YR48400
Tipo	BAC	Group	E2
Capacità	Capacité	Capacity	Ah 48
Norme EN	Normes	Cranking	A 400
Terminali	Bornes	Terminal	A
Attacchi	Fixation	Hold-down	B1
Lay-out	Lay-out	Lay-out	0
Codice DIN	Référence DIN	DIN Code	54577
Peso Batteria	Poids Batterie	Battery Weight	Kg 12,70
Dimensioni	Dimensions	Dimensions	219x133x220



Codice	Référence	Code	YR48401
Tipo	BAC	Group	E2
Capacità	Capacité	Capacity	Ah 48
Norme EN	Normes	Cranking	A 400
Terminali	Bornes	Terminal	A
Attacchi	Fixation	Hold-down	B1
Lay-out	Lay-out	Lay-out	1
Codice DIN	Référence DIN	DIN Code	54579
Peso Batteria	Poids Batterie	Battery Weight	Kg 12,70
Dimensioni	Dimensions	Dimensions	219x133x220



Codice	Référence	Code	YR52
Tipo	BAC	Group	L1B
Capacità	Capacité	Capacity	Ah 52
Norme EN	Normes	Cranking	A 420
Terminali	Bornes	Terminal	A
Attacchi	Fixation	Hold-down	B13
Lay-out	Lay-out	Lay-out	0
Codice DIN	Référence DIN	DIN Code	54459
Peso Batteria	Poids Batterie	Battery Weight	Kg 12,90
Dimensioni	Dimensions	Dimensions	207x175x175



Codice	Référence	Code	YR55
Tipo	BAC	Group	L1
Capacità	Capacité	Capacity	Ah 55
Norme EN	Normes	Cranking	A 460
Terminali	Bornes	Terminal	A
Attacchi	Fixation	Hold-down	B13
Lay-out	Lay-out	Lay-out	0
Codice DIN	Référence DIN	DIN Code	55054
Peso Batteria	Poids Batterie	Battery Weight	Kg 13,90
Dimensioni	Dimensions	Dimensions	207x175x190



gamma

YR
SUPREME LONG LIFE
 AUTO / VL - VEICOLI COMMERCIALI

Codice	Référence	Code	YR63
Tipo	BAC	Group	L2B
Capacità	Capacité	Capacity	Ah 63
Norme EN	Normes	Cranking	A 520
Terminal	Bornes	Termina	A
Attacchi	Fixation	Hold-down	B13
Lay-out	Lay-out	Lay-out	0
Codice DIN	Référence DIN	DIN Code	55593
Peso Batteria	Poids Batterie	Battery Weight	Kg 15,50
Dimensioni	Dimensions	Dimensions	242x175x175



Codice	Référence	Code	YR65
Tipo	BAC	Group	L2
Capacità	Capacité	Capacity	Ah 65
Norme EN	Normes	Cranking	A 540
Terminal	Bornes	Termina	A
Attacchi	Fixation	Hold-down	B13
Lay-out	Lay-out	Lay-out	0
Codice DIN	Référence DIN	DIN Code	55559
Peso Batteria	Poids Batterie	Battery Weight	Kg 16,00
Dimensioni	Dimensions	Dimensions	242x175x190



Codice	Référence	Code	YR75
Tipo	BAC	Group	L3B
Capacità	Capacité	Capacity	Ah 75
Norme EN	Normes	Cranking	A 650
Terminal	Bornes	Termina	A
Attacchi	Fixation	Hold-down	B13
Lay-out	Lay-out	Lay-out	0
Codice DIN	Référence DIN	DIN Code	56530
Peso Batteria	Poids Batterie	Battery Weight	Kg 18,00
Dimensioni	Dimensions	Dimensions	278x175x175



SKG ITALIA

Codice	Référence	Code	YR80
Tipo	BAC	Group	L3
Capacità	Capacité	Capacity	Ah 80
Norme EN	Normes	Cranking	A 670
Terminal	Bornes	Termina	A
Attacchi	Fixation	Hold-down	B13
Lay-out	Lay-out	Lay-out	0
Codice DIN	Référence DIN	DIN Code	57412
Peso Batteria	Poids Batterie	Battery Weight	Kg 20,50
Dimensioni	Dimensions	Dimensions	278x175x190



gamma

YR
SUPREME LONG LIFE
 AUTO / VL - VEICOLI COMMERCIALI

Codice	Référence	Code	YR90
Tipo	BAC	Group	L4B
Capacità	Capacité	Capacity	Ah 90
Norme EN	Normes	Cranking	A 800
Terminali	Bornes	Terminal	A
Attacchi	Fixation	Hold-down	B13/B14
Lay-out	Lay-out	Lay-out	0
Codice DIN	Référence DIN	DIN Code	58042
Peso Batteria	Poids Batterie	Battery Weight	Kg 21,50
Dimensioni	Dimensions	Dimensions	313x175x175



Codice	Référence	Code	YR91
Tipo	BAC	Group	L4B
Capacità	Capacité	Capacity	Ah 90
Norme EN	Normes	Cranking	A 800
Terminali	Bornes	Terminal	A
Attacchi	Fixation	Hold-down	B13/B14
Lay-out	Lay-out	Lay-out	1
Codice DIN	Référence DIN	DIN Code	58043
Peso Batteria	Poids Batterie	Battery Weight	Kg 21,50
Dimensioni	Dimensions	Dimensions	313x175x175



Codice	Référence	Code	YR100
Tipo	BAC	Group	L5
Capacità	Capacité	Capacity	Ah 100
Norme EN	Normes	Cranking	A 820
Terminali	Bornes	Terminal	A
Attacchi	Fixation	Hold-down	B13/B14
Lay-out	Lay-out	Lay-out	0
Codice DIN	Référence DIN	DIN Code	60038
Peso Batteria	Poids Batterie	Battery Weight	Kg 24,30
Dimensioni	Dimensions	Dimensions	353x175x190



Codice	Référence	Code	YR100720
Tipo	BAC	Group	M11
Capacità	Capacité	Capacity	Ah 100
Norme EN	Normes	Cranking	A 720
Terminali	Bornes	Terminal	A
Attacchi	Fixation	Hold-down	B1
Lay-out	Lay-out	Lay-out	0
Codice DIN	Référence DIN	DIN Code	60032
Peso Batteria	Poids Batterie	Battery Weight	Kg 23,00
Dimensioni	Dimensions	Dimensions	303x175x220



gamma

JPN

JAPAN
AUTO ASIATICHE / VL - ASIATIQUE

Codice	Référence	Code	YR100721
Tipo	BAC	Group	M11
Capacità	Capacité	Capacity	Ah 100
Norme EN	Normes	Cranking	A 720
Terminali	Bornes	Terminal	A
Attacchi	Fixation	Hold-down	B1
Lay-out	Lay-out	Lay-out	1
Codice DIN	Référence DIN	DIN Code	60033
Peso Batteria	Poids Batterie	Battery Weight	Kg 23,00
Dimensioni	Dimensions	Dimensions	303x175x220



Codice	Référence	Code	BPJ40300PP	SMF
Tipo	BAC	Group	NS40	
Capacità	Capacité	Capacity	Ah 40	
Norme EN	Normes	Cranking	A 300	
Terminali	Bornes	Terminal	B	
Attacchi	Fixation	Hold-down	B1	
Lay-out	Lay-out	Lay-out	0	
Codice DIN	Référence DIN	DIN Code	53521	
Peso Batteria	Poids Batterie	Battery Weight	Kg 10,00	
Dimensioni	Dimensions	Dimensions	195x127x200	



Codice	Référence	Code	BPJ40310PP	SMF
Tipo	BAC	Group	NS40	
Capacità	Capacité	Capacity	Ah 40	
Norme EN	Normes	Cranking	A 300	
Terminali	Bornes	Terminal	B	
Attacchi	Fixation	Hold-down	B0	
Lay-out	Lay-out	Lay-out	0	
Codice DIN	Référence DIN	DIN Code	53520	
Peso Batteria	Poids Batterie	Battery Weight	Kg 10,00	
Dimensioni	Dimensions	Dimensions	195x127x200	



SKG ITALIA

Codice	Référence	Code	BPJ40311PP	SMF
Tipo	BAC	Group	NS40	
Capacità	Capacité	Capacity	Ah 40	
Norme EN	Normes	Cranking	A 300	
Terminali	Bornes	Terminal	B	
Attacchi	Fixation	Hold-down	B0	
Lay-out	Lay-out	Lay-out	1	
Codice DIN	Référence DIN	DIN Code	53522	
Peso Batteria	Poids Batterie	Battery Weight	Kg 10,00	
Dimensioni	Dimensions	Dimensions	195x127x200	



Elementi Elettrici

gamma

JPN

JAPAN
AUTO ASIATICHE / VL - ASIATIQUE

Codice	Référence	Code	BPJ48400PP	SMF
Tipo	BAC	Group	NS60	
Capacità	Capacité	Capacity	Ah 48	
Norme EN	Normes	Cranking	A 400	
Terminali	Bornes	Terminal	B	
Attacchi	Fixation	Hold-down	B0	
Lay-out	Lay-out	Lay-out	0	
Codice DIN	Référence DIN	DIN Code	54578	
Peso Batteria	Poids Batterie	Battery Weight	Kg 12,00	
Dimensioni	Dimensions	Dimensions	236x127x200	



Codice	Référence	Code	BPJ48401PP	SMF
Tipo	BAC	Group	NS60	
Capacità	Capacité	Capacity	Ah 48	
Norme EN	Normes	Cranking	A 400	
Terminali	Bornes	Terminal	B	
Attacchi	Fixation	Hold-down	B0	
Lay-out	Lay-out	Lay-out	1	
Codice DIN	Référence DIN	DIN Code	54578	
Peso Batteria	Poids Batterie	Battery Weight	Kg 12,00	
Dimensioni	Dimensions	Dimensions	236x127x200	



Codice	Référence	Code	BPJ74550	SMF
Tipo	BAC	Group	80D26	
Capacità	Capacité	Capacity	Ah 74	
Norme EN	Normes	Cranking	A 550	
Terminali	Bornes	Terminal	A	
Attacchi	Fixation	Hold-down	B0	
Lay-out	Lay-out	Lay-out	0	
Codice DIN	Référence DIN	DIN Code	57024	
Peso Batteria	Poids Batterie	Battery Weight	Kg 15,80	
Dimensioni	Dimensions	Dimensions	258x171x200	



Codice	Référence	Code	BPJ74551	SMF
Tipo	BAC	Group	80D26	
Capacità	Capacité	Capacity	Ah 74	
Norme EN	Normes	Cranking	A 550	
Terminali	Bornes	Terminal	A	
Attacchi	Fixation	Hold-down	B0	
Lay-out	Lay-out	Lay-out	1	
Codice DIN	Référence DIN	DIN Code	57029	
Peso Batteria	Poids Batterie	Battery Weight	Kg 15,80	
Dimensioni	Dimensions	Dimensions	258x171x200	



Profumazioni



ARBRE MAGIQUE®
Agrumi di Capri



ARBRE MAGIQUE®
Alpine Pine



ARBRE MAGIQUE®
Amber Cologne



ARBRE MAGIQUE®
Anguria



ARBRE MAGIQUE®
Aria di Portofino



ARBRE MAGIQUE®
Auto Nuova



ARBRE MAGIQUE®
Black Pine



ARBRE MAGIQUE®
Black Rose



ARBRE MAGIQUE®
Brezza di Mykonos



ARBRE MAGIQUE®
Bubblegum



ARBRE MAGIQUE®
Cocco



ARBRE MAGIQUE®
Coffee Aroma

Profumazioni



ARBRE MAGIQUE®
Coffee Aroma



ARBRE MAGIQUE®
Double Essence Green Forest & Bergamot



ARBRE MAGIQUE®
Double Essence Jasmine & Narcissus



ARBRE MAGIQUE®
Double Essence Mango & Papaya



ARBRE MAGIQUE®
Double Essence Violet & Gardenia



ARBRE MAGIQUE®
Fragola



ARBRE MAGIQUE®
Fresh Water



ARBRE MAGIQUE®
Muschio Bianco



ARBRE MAGIQUE®
Fruit Cocktail



ARBRE MAGIQUE®
Ibiza Cocktail



ARBRE MAGIQUE®
Italian Leather



ARBRE MAGIQUE®
Jungle Fever

Profumazioni



ARBRE MAGIQUE®
Lavanda



ARBRE MAGIQUE®
Spring Flowers



ARBRE MAGIQUE®
Summer Dream



ARBRE MAGIQUE®
Lemon



ARBRE MAGIQUE®
Spring Flowers



ARBRE MAGIQUE®
Mela Verde



ARBRE MAGIQUE®
Vaniglia



ARBRE MAGIQUE®
Menta Glaciale



ARBRE MAGIQUE®
Summer Dream



ARBRE MAGIQUE®
Vaniglia



Tanichetta 5 litri



Delfin
g r o u p



Tanica
20 litri

Lattina
1 litro



Fusto 208 litri



Fusto 60 litri

DacCar Oil[®]

Chimici e Lubrificanti

CODE	DaCar Oil	Package
DA100-1	DaCar Oil 0W20 SN/GF-5 F. Syntetic	12X1
DA100-5	ACEA A1/B1	4x5
DA100-20	VW 508.00 / 509.00	20
DA100-60	VOLVO VVC RBS0-2AE	60
DA100-208	RENAULT RN 17FE	208
DA100-1000	DEXOS 1	1000
DA000-1	DaCar Oil 0W30 SN/CF F. Syntetic	12X1
DA000-5		4x5
DA000-20	ACEA C3 - MB 229/31 - 229/51	20
DA000-60	BMW LL-04 DEXOS 2	60
DA000-208	RENAULT RN 0700/0710	208
DA000-1000		1000
DA001-1	DaCar Oil 5W30 SN/CF F. Syntetic	12X1
DA001-5		4x5
DA001-20	ACEA A3/B3, A3/B4, C3	20
DA001-60	VW 504.00/507.00, BMW LL-04	60
DA001-208		208
DA001-1000		1000
DA002-1	DaCar Oil 5W40 SN/CF F. Syntetic	12X1
DA002-5		4x5
DA002-20	ACEA A3/B3, A3/B4, C3	20
DA002-60	VW 502.00/ 505.00/506.01, BMW LL-04	60
DA002-208		208
DA002-1000		1000
DA003-1	DaCar Oil 5W30 SM/CF T. Syntetic	12X1
DA003-5		4x5
DA003-20	ACEA A3/B3/B4, MB 229,3	20
DA003-60	VW 502.00/505.00, BMW LL-01	60
DA003-208		208
DA003-1000		1000
DA004-1	DaCar Oil 5W40 SM/CF T. Syntetic	12X1
DA004-5		4x5
DA004-20	ACEA A3/B3/B4, MB 229,3	20
DA004-60	VW 502.00/505.00, BMW LL-01	60
DA004-208		208
DA004-1000		1000
DA005-1	DaCar Oil 10W40 SL/CF T. Syntetic	12x1
DA005-5		4x5
DA005-20	ACEA A3/B3/B4, MB 229,3	20
DA005-60	VW 502.00/505.00, BMW LL-01	60
DA005-208		208
DA005-1000		1000

Chimici e Lubrificanti

CODE	DaCar Oil	Package
DA007-1	DaCar Oil 15W40 SL/CF Mineral	12x1
DA007-5		4x5
DA007-20		20
DA007-208	ACEA A3/B3/B4, MB 229,3	208
DA007-1000	VW 502.00/505.00, BMW LL-01	1000
DA009-5	DaCar Oil 15W40 Mineral	4X5
DA009-20	CI-4 / CH-4 / CG-4 / CF-4 - ACEA E7/A3/BA	20
DA009-208	MB 228.3 - DEUTZ DQC-III-05	208
DA009-1000	MAN 3275 - VOLVO VDS-3 - RN VI RLD-2	1000
DA010-1	DaCar Oil ATF III T. Syntetic	12X1
DA010-5		4x5
DA010-1000		1000
DA013-1	DaCar Oil 75W90 GL4 T. Syntetic	12X1
DA013-5		4x5
DA013-20		20
DA014-1	DaCar Oil 80W90 GL4 Mineral	12X1
DA014-5		4x5
DA014-20		20
DA014-208		208
DA015-1	DaCar Oil 2T F. Syntetic	12X1
DA015-5		4x5
DA016-1	DaCar Oil 2T T. Syntetic	12X1
DA016-5		4x5
DA017-5	DaCar Oil Hydra 32	4X5
DA017-20		20
DA017-208		208
DA017-1000		1000
DA018-5	DaCar Oil Hydra 46	4X5
DA018-20		20
DA018-208		208
DA018-1000		1000
DA019-5	DaCar Oil Hydra 68	4X5
DA019-20		20
DA019-208		208
DA019-1000		1000
DA020-1	DaCar Oil Chainsaw Oil	12X1
DA020-5		4X5
DA020-208		208
DA020-1000		1000
DA021-5	DaCar Oil 10W30 Multifunzione Mineral	4X5
DA021-20	API CH-4/CF 4 - ACEA E3 - MB 227/1 - FORD M2B6B	20
DA021-208	ALLISON C4 - MF 1143/45	208

RIFÀTTUTTO TAPE

Nastro in tessuto adesivo di fibra di vetro e poliuretano per riparazioni RIGIDE e STRUTTURALI di EMERGENZA o DEFINITIVE

RifàttuttoTape è un morbido nastro di tessuto di fibra di vetro imbevuto di resina poliuretanicca che indurisce con l'acqua.

Semplicemente bagnando il nastro, si realizzano "fasciature" di riparazione e rinforzo rigide, robuste e durature su qualsiasi materiale e superficie "fasciabile".

Aderisce e si incolla a metalli (acciaio, alluminio, rame), ghisa, legno, vetro, pietra, marmo, plastica, gomma, ceramica, PVC, poliestere, Nylon vetroresina, cemento.

RifàttuttoTape indurisce in 15/30 minuti, una volta polimerizzato completamente può essere forato, carteggiato, levigato, smerigliato, sabbato, piallato; sovraverniciabile.

Caratteristiche e vantaggi:

- 1) Morbido, flessibile ed elastico al momento dell'applicazione. Polimerizza velocemente se precedentemente bagnato con l'acqua, altrimenti indurisce lentamente anche semplicemente a contatto con l'aria.
- 2) Resistente e stabile fino a temperature vicine a 150 °C.
- 3) Aderisce a qualsiasi materiale e superficie pulita e sgrassata che possa essere "fasciata o avvolta" con cura.
- 4) Rapido indurimento: in 10 minuti, la fasciatura diventa rigida e l'indurimento strutturale si ottiene trascorse 24 ore.
- 5) Quando indurito è resistente all'acqua, alla maggior parte dei solventi e carburanti.
- 6) Resistente all'abrasione.
- 7) Resistente alle pressioni interne fino a 10 kg/cmq.
- 8) La benda non è elastica all'applicazione e non ha ritiro all'indurimento.
- 8) Prolungabile: la fine di una fascia si unisce perfettamente all'inizio di un'altra.
- 9) Con la confezione chiusa, ha scadenza indeterminata.
- 10) Di uso facile e sicuro; non è tossica, non ha odore.
- 11) Misura 5 x 150 cm.

Confezioni e codici



Prodotto in scatola
P00802

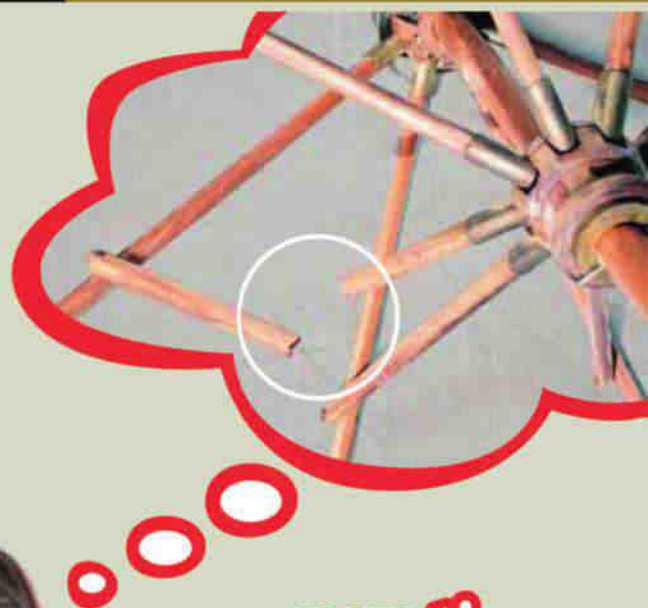

**non ti
preoccupare,
da oggi
puoi...**



...riparare tutto e qualcosa in più!



basta bagnare...



... fasciare...



... riparato!



Aderisce a metalli (acciaio, alluminio, rame...), ghisa, legno, vetro, pietra, marmo, plastica, gomma, ceramica, PVC, poliestere, Nylon, vetroresina, cemento.

Semplicemente bagnando il nastro, si realizzano "fasciature" di riparazione e rinforzo rigide, robuste e durature su qualsiasi materiale e superficie "fasciabile".

RifàtuttoTape indurisce in 15/30 minuti e, una volta polimerizzato completamente, può essere forato, carteggiato, smerigliato, levigato, sabbato, piallato e verniciato.

**Resistente come l'acciaio
in pochi minuti**



5-56 IL LUBRIFICANTE MULTIFUNZIONALE



Per impiego professionale



Per il fai da te



Per il tempo libero

IL 5-56 HA MOLTI VANTAGGI

È un anticorrosivo attivo

Cioè non si limita ad isolare le superfici ricoprendola con un velo d'olio; i suoi componenti specifici si uniscono al metallo con legame polare e gli impediscono di ossidarsi o essere aggredito da agenti corrosivi.

È idrorepellente

Bassa tensione superficiale e affinità per il metallo gli consentono di penetrare anche nelle fessure più minute. Ne espelle l'acqua proveniente da lavaggi, risciacqui o da condensazione dell'umidità atmosferica per effetto capillare. Ripristina l'isolamento elettrico compromesso da elettroliti. Non contiene siliconi né PTFE e non isola i contatti.

È il più competitivo lubrificante multifunzione

Il propellente è anidride carbonica CO₂, quella che respiriamo nell'aria e beviamo nell'acqua gassata. Per pressurizzare il flacone ne basta pochissima, non più del 3%. Perciò la quantità di prodotto attivo è sempre almeno il 97% in volume del contenuto netto. Vuol dire sempre almeno il 30% in più del contenuto effettivo di un aerosol pressurizzato con il propano-butano (che costituisce tra il 30 e il 50% del volume nominale del flacone, che rende la confezione altamente infiammabile e che unito all'aria forma miscela esplosiva).

Altri aerosol presenti sul mercato



Propellente gas liquefatto propano-butano

Prodotto attivo

CRC 5-56 Super



Propellente CO₂ max 3%

Prodotto attivo min 97%

IL 5-56

- Penetra
- Lubrifica
- Elimina i cigolii
- Sblocca rapidamente le parti ossidate
- Espelle l'umidità
- Ripristina l'isolamento elettrico
- Consente l'avviamento dei motori bagnati
- Non isola i contatti elettrici
- Protegge i metalli contro la corrosione
- Deterge
- Non occorre rimuoverlo
- L'aerosol contiene il 97% di prodotto attivo
- Non contiene solventi clorurati
- L'aerosol è esente da CFC e GPL
- L'aerosol può spruzzare anche capovolto
- È certificato ISO 9001

HA INNUMEREVOLI APPLICAZIONI

AUTO terminali della batteria, alternatore, bobina, distributore, cavi, candele, comandi, chiusure, antenna, dadi, bulloni, cerniere, cromature, gomma, vinile, guide dei sedili...

INDUSTRIA operazioni di processo, manutenzione, lavorazioni, riparazioni, stoccaggio, trasporto, parti elettriche...

CASA serrature, cerniere, motori elettrici, elettrodomestici (caldaie, ventilatori, lucidatrici, aspirapolveri, orologi, lavatrici, lavastoviglie, condizionatori), lampade ed elettroserrature esterne, lucchetti, interruttori, temporizzatori, porte automatiche, porte e finestre scorrevoli, saracinesche, avvolgibili, cassette, giocattoli, ruote, carrelli...

GIARDINO E ORTO tagliaerba, decespugliatori, motoseghe, motopompe, motocoltivatori, forbici per potare, raccordi, fascette, spazzatrici, scale metalliche, irrigatori temporizzati, arnesi di ogni tipo...

FAI DA TE mandrini, utensili elettrici (seghe, mole, smerigliatrici, trapani, torni), motogeneratori, pompe, interruttori, teleruttori, morsetti, arnesi, attrezzi...

TEMPO LIBERO biciclette, moto e motorini, pattini, skateboard, apparecchi per ginnastica, mulinelli da pesca, attrezzature per campeggio, attacchi per sci...



Aerosol
100 ml
C2600



Aerosol
200 ml
C2615



Aerosol 2spray
300 ml
C2616



Aerosol
400 ml
C2612



Latta
1 Litro
C2609



Tanica
5 litri
C2614

5-56 Super

**Sbloccante. Lubrificante. Idroespellente.
Anticorrosivo. Detergente.**

Sbloccante a rapida azione.

Lubrificante fortemente penetrante. Idroespellente

Anticorrosivo attivo. Detergente

- Penetra nelle fessure più minute. Espelle l'umidità anche se trattenuta per effetto capillare.
- Interrompe i cortocircuiti e le dispersioni di corrente causati da elettroliti.
- Non contiene siliconi. Non isola i contatti. Non fa arco. Non occorre rimuoverlo.
- Scioglie residui oleosi e macchie. Non danneggia le vernici isolanti.
- Ripristina le caratteristiche elettriche originali dei circuiti e la piena efficienza funzionale, anche in ambienti altamente umidi.
- Non ha scadenza. Compatibile con la maggioranza dei materiali.
- Mediante azione prolungata o ripetuta consente l'avviamento di motori a scoppio umidi o bagnati.

Specifiche: NSN 9150-00-529-7222

USDA class H2, MIL-C-23411A

Caratteristiche tecniche

Aspetto	liquido, ambra, trasparente
Densità (@ 20 °C)	0,82
Temperatura di infiammabilità	65 °C
Temperatura di congelamento	< -50 °C
Tensione superficiale	22 mN/m
Spessore medio del film (@ 20 °C, dopo 24 ore)	1 ÷ 2 µm
Copertura (@ 20 °C, dopo 24 ore)	100 m ² /l
Proprietà del film dopo evaporazione dei solventi:	
Densità (@ 20 °C)	0,88
Viscosità dinamica (@ 40 °C)	26 mPa·s
Carico massimo Hertz (FTMS 791-6503.2)	930 N





6-66 Marine

Multifunzione per ambiente salmastroso.

Protettivo specifico contro l'azione corrosiva e cortocircuitante delle atmosfere salmastrose. Idrorepellente. Non altera la conducibilità dei contatti elettrici. Sblocca, deterge e lubrifica.

- Aderisce intimamente ai metalli, si spande e penetra nelle cricche più minute, ne espelle gli elettroliti trattenuti per capillarità, dissolve i grumi di grassi, polvere e sali, abbassa il coefficiente di attrito e la tensione superficiale all'interfaccia metallo/ossido.
- Arresta i processi corrosivi in corso e impedisce il manifestarsi di nuovi attacchi, in particolare se innescati dai sali tipici dell'ambiente marino. Protettivo specifico per natanti, attrezzature portuali e cantieristiche, impianti e veicoli operanti in zone costiere.
- Elimina le dispersioni di corrente ed i cortocircuiti dovuti a elettroliti, specialmente salini. Non contiene siliconi, non isola contatti o connessioni. Previene il danneggiamento e ripristina la funzionalità di motori marini, quadri ed apparecchi elettrici, meccanismi delicati umidi o bagnati, anche se da acqua di mare.
- Deterge parti elettriche o meccaniche eliminando morchie, gomme, lubrificanti ossidati o bruciati o aggrumati con polvere e sali, tutti inneschi potenziali di combustione, cortocircuiti, corrosione.
- Sblocca, conferisce di nuovo piena precisione di movimento, protegge in esercizio o durante lo svernaggio vinci, schiavi, arridatoi, salpaancore, avvolgifiocco, serrature, impianto elettrico. Arresta o previene quasi tutte le avarie elettromeccaniche imputabili all'atmosfera marina umida e corrosiva.

Specifiche NATO: NSN 6850 131151885

Caratteristiche tecniche

Aspetto	liquido, blu-verde, trasparente
Densità (@ 20 °C)	0,83
Intervallo di distillazione	190 °C ÷ 250 °C
Temperatura di congelamento	- 50 °C
Viscosità dinamica (@ 20 °C)	3,9 mPa·s
Spessore medio del film (@ 20 °C, dopo 24 ore)	2 µm
Copertura (@ 20 °C, dopo 24 ore)	100 m ² /l
Evaporazione dei solventi	2 ÷ 4 ore
Proprietà del film dopo evaporazione dei solventi:	
Viscosità dinamica (@ 20 °C)	64 mPa·s
Carico massimo Falex (ASTM D 3233, Proc. A)	8900 N
Resistenza alla nebbia salina	65 ore
Temp. massima di esercizio	120 °C (150 °C intermittente)



**Nuova confezione
6-66 marine 300 ml
con valvola 2spray**





Confezioni e codici



Synpol®

THE ULTIMATE SOLUTION

SYNPOL CREMA

SYNPOL CREMA è la soluzione più innovativa per far risplendere la tua auto e la tua moto come nuove, senza l'utilizzo di acqua, nel tempo.

Grazie alla sua esclusiva formula a 10 componenti attivi, pulisce, lucida e protegge in maniera efficace e perfetta tutte le tipologie di superfici non porose.

I suoi potenti elementi detergenti rimuovono senza fatica catrame, insetti, resina, residui di collanti (per es. da autoadesivi), grasso, smog, ecc. Anche senza un lavaggio classico preventivo (necessario solo se il mezzo è sporco di terra o fango).

Il trattamento infatti è "waterless" (senza l'utilizzo di acqua), rendendo così possibile un lavaggio vero e proprio nel rispetto dell'ambiente ed eliminando lo spreco di un bene prezioso come l'acqua.

SYNPOL CREMA permette la perfetta applicabilità su tutte le parti dell'auto e della moto: carrozzeria, fascioni in plastica, vetri, specchi, cerchi in acciaio e in lega, parti in gomma, cromature, cupolini in plexiglas. Non contenendo cere e siliconi non ha controindicazioni per il suo utilizzo, per esempio non lascia macchie bianche su parti in plastica e in gomma nere, né aloni su vetri o specchi. Le superfici trattate risulteranno perfettamente lucide come nuove, e le verniciature anche datate torneranno a splendere.

La funzione protettiva del trattamento SYNPOL CREMA è assicurata dal PTFE, uno dei suoi importanti componenti con effetto antiaderente, il quale evita l'attacco degli agenti atmosferici e dello sporco, facilitandone la successiva rimozione, anche con una semplice passata.

SYNPOL CREMA non è una pasta quindi non è necessario fare fatica per trattare completamente anche mezzi imponenti come SUV, autocarri, camion, pullman, barche, etc.

SYNPOL CREMA è un trattamento completo di pulizia e lucidatura per tutte le superfici e pertanto fa risparmiare sull'acquisto di ulteriori prodotti.

SYNPOL CREMA è concentrato e ne basta poco: 60 ml. sono sufficienti per trattare completamente un'auto di medie dimensioni, riportandola a nuovo. Quantità maggiori di prodotto non migliorano il risultato anzi costituiscono solo uno spreco inutile.

Art.SY402



Synpol[®]

THE ULTIMATE SOLUTION

SYNPOL DELUXE

SYNPOL DELUXE è un prodotto per la pulizia, la lucidatura e la protezione di tutte le superfici di auto, moto, camper, barche, etc.

Grazie ai suoi potenti componenti detergenti permette un lavaggio approfondito senza l'utilizzo di acqua e rimuove senza fatica catrame, insetti, resina, residui di collanti (per es. da autoadesivi), grasso, smog, ecc.

SYNPOL DELUXE si applica efficacemente su: carrozzeria, fascioni in plastica, vetri, specchi, cerchi in acciaio e in lega, parti in gomma, cromature, cupolini e fnestrini in plexiglas, fibra di vetro, fibra di carbonio, alluminio, etc. Non contenendo né cere né siliconi non ha controindicazioni per il suo utilizzo, per esempio non lascia macchie bianche su parti in plastica e in gomma, né aloni su vetri o specchi. Le superfici trattate risulteranno perfettamente lucide come nuove, e le verniciature, anche datate, torneranno a splendere.

La caratteristica distintiva di SYNPOL DELUXE rispetto al SYNPOL CREMA è il suo componente protettivo: la cera di carnauba pura.

La Carnauba è una pianta del Sud America e le sue foglie producono la cera per proteggerla dalle intense condizioni atmosferiche di quella regione. E' la cera naturale più dura e resistente che esista e svolge perfettamente le sue funzioni di protezione su tutte le superfici con essa trattate.

Il risultato è una incredibile brillantezza e vivacità dei colori, particolarmente apprezzata dai possessori di mezzi d'epoca che vedono così rivitalizzate verniciature e cromature opacizzate dal tempo.

SYNPOL DELUXE svolge con uguale efficacia la sua funzione di lucidante protettivo su vetri, plastiche, tutti i tipi di metalli, etc.

SYNPOL DELUXE non è una pasta quindi non è necessario fare fatica per trattare completamente anche mezzi imponenti come SUV, autocarri, camion, pullman, barche, etc.

SYNPOL DELUXE fa risparmiare in quanto è un trattamento completo di pulizia e lucidatura per tutte le superfici e pertanto non è necessario l'acquisto di ulteriori prodotti.

SYNPOL DELUXE è concentrato e ne basta poco: 60 ml. sono sufficienti per trattare completamente un'auto di medie dimensioni, riportandola a nuovo. Quantità maggiori di prodotto non migliorano il risultato anzi costituiscono solo uno spreco inutile.

Art. SY417



Synpol®

THE ULTIMATE SOLUTION

SYNPOL FINISH

Art. SY406

FINISH è una crema leggermente abrasiva che non contiene cere, silicone o ammoniaca.

La sua formula unica permette di utilizzarlo sia come abrasivo sia come crema di rifinitura, senza rischi di danneggiare la verniciatura.

Rimuove imperfezioni di verniciatura, macchie d'acqua, ossidazioni e piccoli graffi velocemente e senza fatica, lasciando una perfetta brillantezza con effetto bagnato.

Ridona vivacità a vernici spente e sbiadite o danneggiate, riportandole all'originale lucentezza.

FINISH è utilizzabile con i panni CLEANER o con la macchina lucidatrice sulla carrozzeria.



MODALITA' D'USO :

Se applicato con l'utilizzo della macchina lucidatrice: versare una piccola quantità di FINISH su un pad e utilizzare una velocità tra gli 800 e i 2500 giri al minuti a seconda della rifinitura desiderata.

Applicare a zone con poca pressione. In seguito lucidare con un pad morbido pulito.

Se applicato a mano raccomandiamo l'uso del panno morbido CLEANER di Synpol e di cambiare spesso la parte di panno utilizzato.

Per aggiungere una protezione durevole alle parti trattate raccomandiamo l'uso di SYNPOL CREMA o SYNPOL DELUXE

APPLICABILITA' :

FINISH si applica su tutte le parti metalliche. E' da evitare il contatto con parti in plastica o gomma perché potrebbero rimanere macchiate.

ASSISTENZA PNEUMATICI

GONFIAERIPARA è il marchio INTEC per i kit di riparazione rapida degli pneumatici, dalla bicicletta al veicolo commerciale la foratura non è più un problema.

In pochi minuti potrete ripartire senza affrontare il pesante compito di sostituire la ruota.

Lo speciale liquido sigillante AIRMAN è in grado di riparare forature causate da oggetti fino a 10mm di diametro, è omologato da primarie case costruttrici ed è pienamente compatibile con i sensori TPMS (Tire Pressure Monitoring System) di serie sui veicoli di ultima generazione.

Il piccolo VT100 è il primo sistema dedicato al mondo delle moto che non richiede la rimozione del valvolino.

E se la riparazione non fosse possibile, l'esclusiva polizza Europ Assistance vi garantisce 2 anni di soccorso su strade e autostrade di tutta Europa e per veicoli fino a 35 q.li immatricolati in Italia.

Per il gommista disponiamo di una serie di attrezzature in grado di rendere più facile il trasporto ed il montaggio delle ruote, nonché il loro stallonamento e ritallonamento, un compito spesso difficile e delicato. La serie BEAD BAZOOKA, un'esclusiva di INTEC oggi disponibile anche per i grandi veicoli agricoli o movimento terra.

GONFIAERIPARA



EUROP ASSISTANCE

Tutti i prodotti GONFIAERIPARA sono dotati di una polizza di assistenza stradale Europ Assistance valida due anni su strade e autostrade di tutta Europa per veicoli fino a 35 quintali.



PICCOLO E POTENTE

VT100

Il VT100 è il primo kit studiato per il mondo delle due ruote e degli ATV (Quad, tricicli etc) che non richiede lo smontaggio del valvolino. Le sue dimensioni estremamente compatte ne rendono possibile lo stivaggio in qualsiasi sottosella, vano attrezzi, bauletto. La confezione comprende un potente compressore da 8A, il serbatoio del liquido sigillante e diversi accessori di connessione alla batteria della moto (pinze, occhielli, cavo accendisigaro). Il liquido sigillante è rimovibile con semplice acqua e non danneggia i sistemi TPMS. Codice ricambio: VT100SP.



KC74

È il sistema più economico e pratico per la riparazione degli pneumatici delle moto e delle vetture di piccola e media cilindrata. Richiede lo smontaggio del valvolino, operazione resa semplice da uno speciale accessorio. Codice ricambio: KC74SP.



VT300

Il Gonfiaeripara VT300 è il kit di Intec per vetture di piccola e media cilindrata. È un prodotto ampiamente utilizzato in primo impianto per la sua sicurezza e semplicità d'uso, in quanto non richiede lo smontaggio del valvolino. La speciale formulazione del liquido sigillante, rimovibile con acqua, non influisce sulla funzionalità del sistema TPMS. Compressore con alimentazione 12V. Codice ricambio: VT300SP.



	VT100	KC74	VT300
POTENZA COMPRESSORE	8A	10A	10A
ALIMENTAZIONE	12V - occhielli, pinze o spina accendisigari	12V - spina accendisigari	12V - spina accendisigari
QUANTITÀ LIQUIDO	100 ml	300 ml	300 ml
DIMENSIONI	110x95x70 mm	200x150x80 mm	205x155x85 mm
PESO	650 gr	1,1 Kg	1,2 Kg



EUROP ASSISTANCE

Tutti i prodotti GONFIAERIPARA sono dotati di una polizza di assistenza stradale Europ Assistance valida due anni su strade e autostrade di tutta Europa per veicoli fino a 35 quintali.

VT440

Il più moderno sistema integrato di riparazione pneumatici oggi disponibile sul mercato, offre all'automobilista la massima comodità e rapidità di utilizzo in caso di bisogno. La scelta tra semplice regolazione della pressione e riparazione del pneumatico avviene per mezzo di un comodo selettore. La quantità di liquido e la potenza del compressore permettono di operare anche su vetture di grossa cilindrata e SUV. Codice ricambio VT440SP.



"ALL IN ONE"

VT450

Sistema di riparazione pneumatici comodo e di rapido utilizzo in caso di bisogno. La quantità di liquido e la potenza del compressore permettono di operare anche su vetture di grossa cilindrata e SUV. Il liquido sigillante è compatibile con i sistemi TPMS e può essere rimosso con acqua. Non richiede lo smontaggio del valvolino, in dotazione gli accessori di gonfiaggio per palloni, biciclette etc. Alimentazione 12V. Codice ricambio VT450SP.



VT620

Uno speciale kit di Gonfiaeripara sviluppato per camper, caravan e furgoni, che richiedono alte pressioni di gonfiaggio con volumi d'aria molto elevati. Il kit comprende un potente compressore da 12V-15A dotato di cavi di alimentazione da 8 metri per poter arrivare anche alle ruote posteriori del furgone, mentre la connessione avviene direttamente sui poli della batteria per non sottoporre la presa accendisigari a carico eccessivo. Codice ricambio VT620SP.



	VT440	VT450	VT620
POTENZA COMPRESSORE	15A	10A	15A
ALIMENTAZIONE	12V - spina accendisigari	12V - spina accendisigari	12V - pinze
QUANTITÀ LIQUIDO	440 ml	450 ml	620 ml
DIMENSIONI	300x160x70 mm	250x150x70 mm	280x170x100 mm
PESO	1,9 Kg	1,5 Kg	2,3 Kg



VT100SP

Liquido ricambio per VT100



KC74SP

Liquido ricambio per KC74



VT300SP

Liquido ricambio per VT300



VT440SP

Liquido ricambio per VT440



VT450SP

Liquido ricambio per VT450



VT620SP

Liquido ricambio per VT620



65-005

Ricambio conforme all'originale per vetture delle seguenti case automobilistiche: Audi, BMW, Citroen, Chevrolet, Daewoo, FIAT, Ford, Hunday, Kia, Mazda, Mercedes-Benz, Mitsubishi, Nissan, Opel, Peugeot, Renault, Saab, Seat, Skoda, Subaru, Suzuki, Toyota, Volvo, Volkswagen. **ATTENZIONE:** la compatibilità riguarda il liquido sigillante, il modello di bottiglia e di attacco deve essere verificato tramite confronto con la dotazione di serie.

	VT100SP	KC74SP	VT300SP	VT440SP	VT450SP	VT620SP	65-005
QUANTITÀ LIQUIDO	100 ml	300 ml	300 ml	440 ml	450 ml	620 ml	450 ml
DIMENSIONI	110x95x35 mm	75x75x130 mm	70x70x160 mm	60x60x230 mm	85x85x135mm	85x85x160mm	85x85x135mm
PESO	0,2 Kg	0,4 Kg	0,5 Kg	0,7 Kg	0,7 Kg	1,0 Kg	0,7 Kg



Art. WD40100 Flacone spray 500ml

Il prodotto WD-40 Prodotto Multifunzione lubrifica, elimina cigolii, sblocca, toglie l'umidità, previene la ruggine e protegge tutte le superfici metalliche. Rimuove persino macchie di grasso, catrame e colla da qualunque superficie non porosa.



Art. WD40391078 Grasso Multiuso 400 gr

Art. WD40391078 Grasso Multiuso 150 gr

Con la sua formula addensata con Solfonato di Calcio garantisce prestazioni migliorate in condizioni estreme, come maggiore resistenza all'usura sotto carichi o pressioni elevate ed elevata protezione contro acqua, ruggine e corrosione, soprattutto in ambienti umidi o caldi.

RPS
LINE

Liquido per circuiti sigillati FLU' GEL - 20 1000 ml 24 pc



Liquido permanente per circuiti sigillati, protegge l'impianto di raffreddamento fino a -20°C e $+110^{\circ}\text{C}$ evitando il congelamento del liquido nel periodo invernale e allontanando il rischio di ebollizione. Grazie agli speciali inibitori, protegge il radiatore da incrostazioni di calcare e di ruggine. Non intacca le tubazioni in gomma dell'impianto ed evita la formazione della schiuma nel radiatore.

BLU Cod. RP00162
ROSSO Cod. RP00162/R

Antigelo puro FLU' GEL 1000 ml 24 pcs

Liquido per circuiti sigillati allo stato puro, protegge l'impianto di raffreddamento evitando il congelamento del liquido nel periodo invernale e allontana i rischi di ebollizione nel periodo estivo. Grazie agli speciali inibitori impedisce la formazione di incrostazioni calcaree e di ruggine. Non intacca le tubazioni in gomma dell'impianto.



BLU Cod. RP00150
ROSSO Cod. RP00150/R
GIALLO Cod. RP00150/G



RPS
LINE

Antigelo puro FLU' GEL Kg. 5

Liquido per circuiti sigillati allo stato puro, protegge l'impianto di raffreddamento evitando il congelamento del liquido nel periodo invernale e allontana i rischi di ebollizione nel periodo estivo. Grazie agli speciali inibitori impedisce la formazione di incrostazioni calcaree e di ruggine. Non intacca le tubazioni in gomma dell'impianto.



BLU Cod. RP00150/5
ROSSO Cod. RP00150/5 R
GIALLO Cod. RP00150/5 G



Antigelo puro FLU' GEL Kg. 25

Liquido per circuiti sigillati allo stato puro, protegge l'impianto di raffreddamento evitando il congelamento del liquido nel periodo invernale e allontana i rischi di ebollizione nel periodo estivo. Grazie agli speciali inibitori impedisce la formazione di incrostazioni calcaree e di ruggine. Non intacca le tubazioni in gomma dell'impianto.



BLU Cod. RP00150/25 B
ROSSO Cod. RP00150/25 R
GIALLO Cod. RP00150/25 G



RPS
LINE

Detergente parabrezza LAVAVETRI 5 lt 10 lt



LAVAVETRI è un detergente anticongelante ad alta concentrazione, da aggiungere nella apposita vaschetta dei tergicristalli. Sgrassa e pulisce anche le macchie più forti eliminando tracce di insetti, grasso, unto assicurando una perfetta visibilità. Impedisce la formazione di ghiaccio sia nella vaschetta che sul parabrezza.

Cod. RP00111/5 Tan. 5 Lt.

Liquido per vaschette LAVAVETRI 250ml 1000 ml 24 pcs



Detergente profumato per vaschette tergicristallo in grado di eliminare a fondo lo sporco untuoso, smog moscerini ecc. senza lasciare aloni e garantendo una perfetta visibilità.

Particolarmente adatto per impianti lavafari, nella stagione invernale garantisce un punto di congelamento pari a -25° C. Evita la formazione di calcare nella pompa e nelle tubazioni dell'impianto lavacristalli.

Cod. RP00111/250

Cod. RP00111/1



BRAKE FLUID DOT 4 1.000 ml -250 ml olio freni



Fluido freni ideale per impianti frenanti a disco e a tamburo, garantisce sempre una frenata sicura e non provoca il rigonfiamento delle tubazioni e della gomma. Il prodotto è igroscopico e può danneggiare la vernice. Punto di ebollizione: 260°C. BRAKE FLUID è conforme alle specifiche internazionali SAE J1703 IISO 4925 - FMVSS571 - 116.

Cod. RPS00140/250

Cod. RPS00140/1

Pasta lavamani FRUIX SPECIAL MIX 1 kg 4 kg



Fruix è una pasta lavamani a base di saponi e sostanze abrasive, elimina a fondo qualsiasi tipo di sporco, macchie, grasso, vernice e inchiostro. Gradevolmente profumata, è adatta a meccanici, carrozzieri, tipografi e artigiani in genere. Grazie agli speciali abrasivi utilizzati, NON INTASA GLI SCARICHI.

Cod. RP0124/4

ECO TECH



RPS

**Eco
TECH**

Prodotto per motori EURO4
ed EURO5 con tecnologia SCR

Eco TECH è un prodotto utilizzato nei sistemi SCR per ridurre le emissioni di ossidi di azoto dai gas di scarico dei motori diesel.

MODO D'USO: utilizzare il prodotto in conformità con le norme CEFIC AUS 32, avendo cura di conservare il prodotto al riparo dalla luce solare e da fonti di calore e di usare un imbuto ben pulito.

AVVERTENZE: tenere lontano dalla portata dei bambini
Non ingerire
TEMPERATURA OTTIMALE DI UTILIZZO -5 C° + 30 C°

RPS S.p.A. - Via G. Cesare, 10 - 20139 Milano - Italy - info@rpsline.com

10 LITRI



Art. RP0040

Prodotto per motori EURO 4 - 5 - 6
con tecnologia SCR

Utilizzato nei MOTORI CON sistema SCR per ridurre le emissioni di Ossidi di Azoto dei gas di scarico dei motori diesel

RPS
LINE

Chimici e Lubrificanti



www.super-help.com

Made in Italy



CONTACT CLEANER

Cod. 38200 - 200 ml

Rimuove l'umidità causa di problemi, da tutti i componenti elettrici ed elettronici bagnati. Lascia un rivestimento resistente agli agenti atmosferici e alla corrosione. Strumento di pulizia e cura dei contatti elettrici, con additivi speciali che dissolvono la corrosione.



CHAIN GREASE GRASSO CATENE

Cod. 50150 - 150 ml

Grasso speciale per catene normali e auto-lubrificanti. Eccellenti proprietà di penetrazione. Il Grasso Spray Super Help mantiene le catene, gli o-ring e i giunti perfettamente lubrificati. Riduce la frizione e previene la corrosione. E' resistente all'acqua. La sua consistenza liscia e cremosa garantisce un'ottima protezione alle superfici trattate.



CHAIN LUB

Cod. 50250 - 250 ml

Lubrificante speciale per catene normali e auto-lubrificanti con eccellenti qualità di penetrazione. Aiuta a mantenere le catene, gli o-ring, i giunti perfettamente lubrificati in qualsiasi condizione meteo. Riduce la frizione e previene la corrosione. Resistente all'acqua, con caratteristiche adesive, penetra profondamente nei perni catena e si fissa per formare un film aderente e di lunga durata.



BIKE OIL

Cod. 41150 - 150 ml

OLIO BICI, a base di vaselina. L'Olio Bici Super Help lubrifica tutte le parti in movimento delle biciclette e penetra anche nella parti meno raggiungibili.

Protegge contro la corrosione e la ruggine. Ideale per il rimessaggio invernale. Elimina umidità e acqua. Ottimo utilizzo per catene, ruote dentate, pignoni, pedali, assi e cavi.



LITHIUM GREASE GRASSO AL LITIO

Cod. 26400 - 400 ml

Grasso special a base di litio, con eccellenti caratteristiche di resistenza alla pressione estrema e alle vibrazioni. Ideale per cardini, freni e meccanismi cambio, terminali delle batterie, parti dello sterzo ecc. Lubrificante performante, grasso multi-uso di alta qualità per il settore auto, commerciale e domestico. Garantisce una lubrificazione a lungo termine con eccellenti doti di resistenza all'acqua e al calore.



PTFE LUB SBLOCCANTE

Cod. 27400 - 400 ml

Lubrificante a base di PTFE sbloccante per uso universale. Garantisce protezione contro la ruggine. Evita il grippaggio delle parti in movimento. Ideale per lubrificare e proteggere, catene, cavi, serrature, cambi meccanici, cardini e cerniere. Riduce le frizioni. Il PTFE Lub Super Help è uno sbloccante altamente performante, grazie all'aggiunta di PTFE contenuto nella sua formula.



SUPER STAR MOTOR SPRY AVVIAMENTO

Cod. 37200 - 200 ml / Cod. 37400 - 400 ml

Per un avviamento veloce e facile in qualsiasi condizione di tempo, adatto ai motori benzina e diesel, basta spruzzare nel filtro dell'aria. Formulazione bilanciata che combina solventi attivi e volatili. Gli ingredienti sono attentamente miscelati per garantire il corretto tipo di avviamento nella camera di combustione.



DE-ICER DEGHIACCIANTE

Cod. 35200 - 200 ml

Deghiacciante per parabrezza. Scioglie rapidamente il ghiaccio che si forma su vetri, serrature, fari, ecc. Fornisce una protezione sicura contro il riformarsi del ghiaccio, anche a temperature molto basse. Efficiente e rapido strumento per sgelare ogni tipo di vetro e anche le guarnizioni in gomma delle portiere.



CREAM 4 LEATHER

Trattamento speciale, cura e ammorbidisce qualsiasi tipo di pelle. Formulato specificatamente per pulire, lucidare e proteggere i sedili dell'auto e le imbottiture

in pelle. La combinazione di sostanze emollienti e detergenti forniscono un nutrimento durevole alle superfici trattate, cura e manutenzione della morbidezza naturale, dei colori e del look originale della pelle, prevenendo screpolature.

Lascia una piacevole sensazione di pulito.



TYRE SHINE

Cod. 7400 - 400 ml

Protegge il pneumatico e le parti in gomma preservandone la flessibilità. Evita il deterioramento, migliorando la lucentezza e il colore originale. Pulitore ad azione rapida, schiuma secca. Cura del pneumatico in una sola azione: basta erogare il prodotto per pulire e proteggere il pneumatico. Emulsione polimerica che forma una schiuma attiva sulle superfici del pneumatico.



TYRE REPAIR

Cod. 1200 - 200 ml

Gonfia e ripara per automobile di piccola, media e grossa cilindrata. Prodotto specifico per riparare e rigonfiare istantaneamente, senza smontare la ruota, qualsiasi tipo di pneumatico, con o senza camera d'aria. Agisce a fondo nel pneumatico, formando un film sigillante che assicura una riparazione efficace. Prodotto a base di lattice di gomma che ripara e rigonfia allo stesso tempo pneumatici forati.



SILICONE SPRY

Cod. 23400 - 400 ml

Lubrificante spray a base di olii di silicone di alta qualità, lubrifica e cura la gomma, plastica e i componenti di metallo. Protegge la gomma e le parti in plastica dall'ossidazione. Erogato sulle guarnizioni in gomma, il silicone Super Help aumenta l'azione di scorrimento, migliorando il trattamento e la performance delle parti trattate.



GLASS CLEANER

Cod. 5400 - 400 ml

Rimuove fumo, grasso, polvere, insetti e sporco dai vetri dell'auto, parabrezza, specchi, fari, ecc. Una miscela di tensioattivi, additivi e solventi studiati per pulire efficacemente senza lasciare aloni. Il Lava Cristalli Super Help rimuove lo sporco stradale, il grasso, le impronte delle dita, il fumo, gli insetti e i residui dalle superfici di vetro.



AUTO SHAMPOO

Shampo auto, può essere usato manualmente o con apparati di lavaggio su ogni tipo di veicolo.

CARATTERISTICHE: Pulisce e sgrassa.

APPLICAZIONI: Auto e camion. Barche. Bicicletta. Motocicletta.



GONFIA RIPARA AUTO TYRE REPAIR

Cod. 1300 - 300 ml / Cod. 1500 - 500 ml

Sigilla e rigonfia in pochi secondi, permettendo al conducente di guidare fino alla prima stazione di servizio per esaminare lo stato del pneumatico e/o farlo cambiare da un professionista. Forma un film stabile e duraturo all'interno del pneumatico. Questo film interno dura persino più a lungo dell'intera vita del pneumatico stesso.



FIRE STOP

Cod. 2500 - Sh 400 ml

Ritardante Fiamma di prima necessità. Speciale formula estinguente per estinguere fuochi minori ed evitare l'espansione delle fiamme, qualsiasi sia la loro origine.

Riduce l'espandersi delle fiamme.



SBLOCCANTE TECH 5

Cod. 20200 - ml 200 - Cod. 20400 - 400 ml

Penetra rapidamente, anche nei pori e nelle crepe più sottili delle superfici, lubrificandole. Pulisce le parti trattate eliminando sporco e grasso. Rimuove l'umidità da qualsiasi sistema elettrico e di accensione e aiuta a far partire i motori bagnati. Sblocca le parti arrugginite. Elimina rumori fastidiosi.

Di uso facile, non necessita di smontaggio.



BRAKE CLEANER

Cod. 21400 - 400 ml

Rimuove efficacemente fluidi, grasso, olio e residui solidi. Sgrassa istantaneamente. Riduce gli stridii del disco freno e della frizione. Può essere applicato, senza smontare le parti, risparmiando tempo e costi di manutenzione. Evapora rapidamente. Formula stabile, non macchia e non corrode i metalli.



COCKPIT LUCIDA CRUSCOTTI

Cod. 3250 - 250 ml / Cod. 3400 - 400 ml

Cod. 3750 - 750 ml

Pulisce plastica e gomma. Lucida e fa brillare cruscotti, paraurti, spoiler, tetti in vinile, imbottiti ecc. Rinnova l'interno dell'auto. Mantiene l'elasticità delle guarnizioni in gomma delle portiere e del baule, non appiccica. Forma un film idrorepellente, trasparente, lucido, inerte e che non macchia. Lascia un profumo fresco e fragrante.



TEXTILE CLEANER PULITORE TESSUTI

Cod. 4400 - 400 ml

Shampoo secco altamente performante. Rimuove rapidamente lo sporco. Rimuove lo sporco da tappetini, moquette, stoffe e tutti i tipi di imbottiture. Pulisce i tessuti delicati senza necessità di impregnare o bagnare.

Rinnova le parti trattate lasciando un fresco sentore di pulito all'interno della vettura. Leggermente alcalino, a base acqua. Non danneggia i colori dei tessuti.



MOTOR CLEANER

Cod. 8400 - 400 ml

Pulisce e sgrassa tutti i motori. Gli emulsionanti permettono al prodotto di essere facilmente eliminato con acqua. Se necessario, raccogliere il residuo acquoso sporco e smaltirlo come da regolamento locale. Di facile uso, grazie al suo erogatore. La formulazione di rapido effetto permette di risparmiare tempo. Non lascia nessun odore nel compartimento motore.



CARB & CHOKE CLEANER

Cod. 24400 - 400 ml

Dissolve rapidamente i residui dal carburatore. Rimuove residui di gomma, vernice, lacca, resina, paraffina, catrame e macchie di carburante. Permette avviamenti rapidi e di tenere il minimo senza problemi. Garantisce economia di carburante.



DEGHIACCIANTE SERRATURE DE-ICER FOR LOCKS

Cod. 36050 - 50 ml

Scioglie rapidamente ghiaccio, neve e gelo. Previene il congelamento. Previene la corrosione. Garantisce una lubrificazione duratura. L'aerosol impiega propellente butan propano per mantenere un'ottima pressione anche sul finire dell'erogazione. Provvisto di un erogatore appositamente studiato per far penetrare a fondo il prodotto nella serratura.



ANTIAPPANNANTE ANTIFOG

Cod. 39200 - 200 ml

Applicato al parabrezza previene l'appannamento dell'interno auto. Garantisce una guida sicura, mantenendo il parabrezza e i finestrini trasparenti e puliti. Elimina l'effetto appannamento lasciando il parabrezza pulito a lungo. L'aerosol impiega propellente butan propano per mantenere un'ottima pressione anche sul finire dell'erogazione.



SILICON STICK

Silicone stick per guarnizioni in gomma. Prodotto specifico per uso sulle guarnizioni in gomma della vettura, della barca, camper o per uso domestico. Per la manutenzione e cura delle guarnizioni in gomma. Mantiene le guarnizioni morbide e flessibili sia in estate, evitando che la gomma diventi secca, che in inverno, evitando il congelamento.

Impedisce alle guarnizioni in gomma di congelare attaccandosi alle parti metalliche in inverno.



GONFIA RIPARA BICICLETTA - TYRE REPAIR

Cod. 1100 - 100 ml

Sigilla e rigonfia in pochi secondi, permettendo al conducente di guidare fino alla prima stazione di servizio per esaminare lo stato del pneumatico e/o farlo cambiare da un professionista. Forma un film stabile e duraturo all'interno del pneumatico. Questo film interno dura persino più a lungo dell'intera vita del pneumatico stesso. La bomboletta è fornita di un doppio connettore che consente l'utilizzo con valvole Schrader, Presta e Woods. Di pulito e facile uso con tutti i tipi di pneumatico, con o senza camera d'aria.



TYRE REPAIR QUICK CONNECTION

Cod. 1100 QC - 100 ml

Sigilla e rigonfia in pochi secondi, permettendo al conducente di guidare fino alla prima stazione di servizio per esaminare lo stato del pneumatico e/o farlo cambiare da un professionista. Forma un film stabile e duraturo all'interno del pneumatico. Questo film interno può durare persino più a lungo dell'intera vita del pneumatico stesso. Lo speciale quick connector consente l'utilizzo con valvole Presta e Woods. Di pulito e facile uso con tutti i tipi di pneumatico, con o senza camera d'aria.



CHAIN LUB DRY CONDITION

Cod. 300 - 110 ml

Specialmente studiato e formulato per percorsi in condizioni asciutte e polverose. Penetra, lubrifica, respinge lo sporco e protegge contro la corrosione. Forma un film asciutto che protegge la catena, respingendo lo sporco. L'impiego di ptfè nella sua formula aiuta a minimizzare il contatto "superficie con superficie" creando uno scudo anti frizione. Riduce gli attriti. Per una trasmissione pulita e regolare.



LTX 777 SIGILLANTE PREVENTIVO FORATURA

Cod. 777 - 1000 ml

LTX 777 è un sigillante per pneumatici tubeless, tubolari e camere d'aria. Quando viene agitato si trasforma in schiuma attiva. In caso di foratura LTX777 passa attraverso il foro e polimerizza aumentando il suo peso molecolare sigillando facilmente il foro.



CHAIN LUB WET CONDITION

Cod. 910 - 110 ml

Specialmente studiato e formulato per percorsi in condizioni bagnate e fangose. Penetra, lubrifica, respinge lo sporco e protegge contro umidità e corrosione. Migliora lo scivolamento ed estende la vita della catena, respingendo umidità e fango.



IGIENIZZANTE DETERGENTE SPRAY

Cod. 315 - 150 ml

Igienizzante spray multiuso. Per superfici, ambienti, oggetti, impianti di climatizzazione, autovetture, ambulanze, taxi, camper, mezzi pubblici ed imbarcazioni; arredi, etc. Ideale per igienizzare luoghi molto frequentati, sale d'attesa, palestre, uffici etc.



PURIFYING & CLEANSING HAND SPRAY

Cod. 317 - 100 ml

Soluzione in spray dermatologicamente testata per igienizzare la pelle delle mani. Pratico e di facile utilizzo in ogni situazione. Agisce in pochi secondi senza bisogno di risciacquare. Perfetto da usare sul posto di lavoro, in casa, in viaggio, a scuola ecc. Non necessita di risciacquo, non lascia tracce e asciuga in pochi secondi.

Grazie al contenuto di glicerina vegetale, questo spray contribuisce al mantenimento della naturale idratazione cutanea.



RED SILICON

Cod. 400 - 85 ml

Pasta siliconica alta temperatura di colore rosso. Adatta per saldare il coperchio della testata, calotta, flange, giunti, collettori di scarico, radiatori, ecc. Si incolla a feltro, legno, metallo, gomma, carta, tessuti e vetro. Disponibile nei colori: rosso, nero e grigio. La Pasta Siliconica Super Help forma una guarnizione sostitutiva a base di SILICONE RTV per tutti i giunti che richiedono flessibilità.



BLACK SILICONE

Cod. 401 - 85 ml

Può essere usato sia per sostituire una guarnizione pre-esistente o per rimpiazzare una guarnizione originale su flange con ampia tolleranza o grande differenza in dilatazione termica. Non si può usare per sostituire la guarnizione della testata del cilindro.



GREY SILICONE

Cod. 404 - 85 ml

Sostituisce molte guarnizioni nel settore auto, industria e motori marini. Flange con ampie tolleranze come sulla maggior parte di flange non lavorate. Flange fatte di diversi materiali o fogli di acciaio pressato. Coppa dell'olio, coperchi delle valvole, coperchi ingranaggi di temporizzazione, termostati, pompe acqua, presa tubi, collettori di aspirazione. Non usare per sostituire la guarnizione della testata del cilindro.

PULITORE INIETTORI DIESEL

Specifico per la pulizia degli iniettori dei motori diesel.
Usato regolarmente garantisce partenze rapide.
Scioglie i residui di resine e i depositi di carbonio.
Riduce i consumi e le emissioni inquinanti.
Ideale per la pulizia dei sistemi ad iniezione Common Rail.

Codice	Contenuto	Cartone
•0612	ml. 250	1x24
•0619	L 1	1x12



PULITORE DIESEL FILTRO ANTI PARTICOLATO

Prodotto ad alta concentrazione specifico per la rapida pulizia del filtro anti-particolato FAP/DPF montato su tutti i motori diesel.
Ideale per le vetture che percorrono tragitti di pochi chilometri come le city car con il sistema "Stop & Start" intasando così il filtro.
Ripetere il trattamento ogni 4000 km.

Codice	Contenuto	Cartone
•0614	ml. 250	1x6



TRATTAMENTO MULTIFUNZIONE DIESEL

Aumenta l'efficienza del motore diminuendo i costi di funzionamento.
Ha effetto anti-paraffina sul carburante diesel
Riduce le emissioni nocive e prolunga la durata dei filtri.

Codice	Contenuto	Cartone
•0603	ml. 125	1x48
•0613	ml. 250	1x24
•0605	L 1	1x12



TRATTAMENTO ANTIGELO DIESEL -20

Facilita le partenze a freddo.
Evita la formazione dei cristalli di paraffina fino a -20°C
Tratta tutti i diesel, biodiesel e alpino.

Codice	Contenuto	Cartone
0611	ml. 250	1X24
0606	L 1	1x12



PULITORE INIETTORI BENZINA

Specifico per la pulizia degli iniettori dei motori benzina.
Usato regolarmente garantisce partenze rapide.
Scioglie i residui di resine e i depositi di carbonio.
Riduce i consumi e le emissioni inquinanti.
Ideale per la pulizia dei sistemi ad iniezione Common Rail.

Codice	Contenuto	Cartone
•0608	ml. 250	1x24



TRATTAMENTO MULTIFUNZIONE BENZINA

Additivo multifunzione per benzina verde
Migliora le prestazioni del motore
Riduce il consumo di benzina e le emissioni nocive
Agevola l'azione della marmitta catalitica

Codice	Contenuto	Cartone
•0602	ml. 250	1x24



OTTANO PER BENZINA

Prodotto specifico per aumentare il numero di ottani della benzina verde e biobenzina. Indicato per tutti i motori sia di vecchia che di nuova generazione e per tutti i tipi di marmitte catalitiche. E' idoneo anche per i motori concepiti per benzina rossa e che necessitano di un additivo per incrementare la potenza e proteggere le sedi delle valvole.

Codice	Contenuto	Cartone
•0610	ml. 250	1x6



TRATTAMENTO OLIO MOTORE

Additivo per lubrificanti dei motori diesel e benzina.
Aumenta l'indice di viscosità del lubrificante.
Riduce il consumo di olio e di carburante.
Riduce la corrosione degli organi in movimento.

Codice	Contenuto	Cartone
•0601	ml. 250	1x24
•0621	Galloni 55	Fusto



TRATTAMENTO OLIO CAMBIO DIFFERENZIALE

Additivo speciale per la scatola del cambio e il differenziale.
Aumenta l'indice di viscosità del lubrificante.
Riduce la corrosione degli organi in movimento.

Codice	Contenuto	Cartone
•0604	ml. 210	1x6



PULITORE MOTORE - ONE SHOT

Additivo per la pulizia interna del circuito di lubrificazione dei motori diesel e benzina. Aggiunto all'olio esausto prima del cambio scioglie le morchie, le incrostazioni e i depositi carboniosi presenti nella coppa dell'olio.
Compatibile con tutti gli olii. Si consiglia di fare il trattamento ad ogni cambio olio.

Codice	Contenuto	Cartone
•0600	ml. 250	1x6



LIQUIDO RADIATORE BLU PRONTO USO

Liquido permanente per circuiti sigillati.
Formula speciale anticongelante, anti-ebollizione, antischiuma.
Assicura un'ottima protezione dei circuiti del radiatore.
Idoneo per tutte le stagioni.
Conforme alle norme ASTM, SAE, CUNA sui liquidi anticongelanti.

Codice	Contenuto	Cartone
•0700	L 1	1X12
•0710	Kg 5	1x4
•0720	Kg 30	Tanica



LIQUIDO RADIATORE BLU -22

Liquido permanente per circuiti sigillati.
Formula speciale anticongelante, anti-ebollizione, antischiuma.
Assicura un'ottima protezione dei circuiti del radiatore.
Idoneo per tutte le stagioni.
Conforme alle norme ASTM, SAE, CUNA sui liquidi anticongelanti.

Codice	Contenuto	Cartone
•0701	L 1	1x12
•0721	Kg 5	1X4
•1720	Kg 5 Prof.	1X4
•0731	Kg 30	Tanica



LIQUIDO RADIATORE BLU -40

Liquido permanente per circuiti sigillati.
Formula speciale anticongelante, anti-ebollizione, antischiuma.
Assicura un'ottima protezione dei circuiti del radiatore.
Idoneo per tutte le stagioni.
Conforme alle norme ASTM, SAE, CUNA sui liquidi anticongelanti.

Codice	Contenuto	Cartone
•0741	L 1	1X12
•0793	Kg 5	1X4
•0794	Kg 30	Tanica



LIQUIDO RADIATORE PURO BLU

Liquido permanente per circuiti sigillati.
Formula speciale anticongelante, antiebollizione, antischiuma.
Assicura un'ottima protezione dei circuiti del radiatore.
Da diluire con acqua nella proporzione minima del 50%.
Conforme alle norme ASTM, SAE, CUNA sui liquidi anticongelanti.

Codice	Contenuto	Cartone
•0771	L 1	1x12
•0781	Kg 5	1X4
•0782	Kg 10	Tanica
•0791	Kg 30	Tanica
•0792	Kg 220	Fusto



MARINER ANTICONGELANTE BLU

Antigelo per la protezione invernale del radiatore.
Protezione a lunga durata.
Prodotto concentrato da diluire con acqua.

Codice	Contenuto	Cartone
•070250	L 1	1x12
•0712	Kg 5	1X4
•0722	Kg 30	Tanica
•0732	Kg 220	Fusto



PERMANENT PLUS -40 ROSSO

Liquido permanente per circuiti sigillati.
Antigelo a base organica indicato per motori in lega di alluminio.
Protezione anticorrosione ed antigelo per 4 anni.
Prodotto conforme alle norme
ASTM D3306, VW-TL774D/F, R- 41-01-00/Q

Codice	Contenuto	Cartone
•0768	L 1	1X12
•0778	Kg 5	1x4
•0774	Kg 10	Tanica
•0780	Kg 30	Tanica



PERMANENT PLUS PURO ROSSO

Liquido permanente per circuiti sigillati.
Antigelo a base organica indicato per motori in lega di alluminio.
Protezione anticorrosione ed antigelo per 4 anni.
Da diluire con acqua nella proporzione minima del 40%.
Prodotto conforme alle norme
ASTM D3306, VW-TL774D/F, R- 41-01-00/Q

Codice	Contenuto	Cartone
•0766	L 1	1X12
•0776	Kg 5	1X4
•0786	Kg 10	Tanica
•0796	Kg 30	Tanica
•0797	Kg 220	Fusto



PERMANENT PLUS -40 GIALLO

Liquido permanente per circuiti sigillati.
Antigelo a base organica indicato per motori in lega di alluminio.
Protezione anticorrosione ed antigelo per 4 anni.
Prodotto conforme alle norme
ASTM D3306, VW-TL774D/F, R- 41-01-00/Q

Codice	Contenuto	Cartone
•0769	L 1	1x12
•0779	Kg 5	1X4
•0775	Kg 10	Tanica
•0784	Kg 30	Tanica



PERMANENT PLUS PURO GIALLO

Liquido permanente per circuiti sigillati.
Antigelo a base organica indicato per motori in lega di alluminio.
Protezione anticorrosione ed antigelo per 4 anni.
Da diluire con acqua nella proporzione minima del 40%.
Prodotto conforme alle norme
ASTM D3306, VW-TL774D/F, R- 41-01-00/Q

Codice	Contenuto	Cartone
•0767	L 1	1x12
•0777	Kg 5	1X4
•0787	Kg 10	Tanica
•0798	Kg 30	Tanica



PERMANENT PLUS PURO VIOLA

Liquido permanente per circuiti sigillati.
Antigelo a base organica indicato per motori in lega di alluminio.
Protezione anticorrosione ed antigelo per 4 anni.
Da diluire con acqua nella proporzione minima del 40%.
Prodotto conforme alle norme
ASTM D3306, VW-TL774D/F, R- 41-01-00/Q

Codice	Contenuto	Cartone	Pallet
•0765	L 1	1x12	50X12



LIQUIDO FRENI DOT 4

Liquido speciale per tutti i freni idraulici.
Indicato per impianti frenanti ABS.
Risponde alle norme SAEJ 1703, ISO4925, FMVSS 116 DOT4.
Resiste alle temperature fino a -50°C + 280°C.
Protegge dalla ruggine e dalla corrosione.
Altamente compatibile con tutte le guarnizioni originali in gomma.

Codice	Contenuto	Cartone
• 0704	ml. 250	1X24
• 0744	ml. 500	1x24
• 0714	L. 1	1X12



LIQUIDO SERVOSTERZO ROSSO ATF II D

Fluido lubrificante rosso per c
e giunti idraulici. ambi automatici, servosterzo
Opera efficacemente sia a basse che ad alte temperature.
Prodotto conforme alle più recenti norme internazionali.
sui lubrificanti.

Codice	Contenuto	Cartone
0706	ml. 250	1X24
0705	L. 1	1x24
0715	Kg. 5	1X4



LIQUIDO SERVOSTERZO ATF III D

Raccomandato per cambi automatici, scatole sterzo,
gruppi di riduzione ed ogni altra applicazione
ove sia richiesto un prodotto Dexron III, indicato anche per sostituire
oli di gradazione e livello inferiori (Dexron II).
Fluido per trasmissioni automatiche con caratteristiche
di elevata stabilità al taglio, elevato indice di viscosità,
ridotta formazione di schiuma e notevoli proprietà
antiusura ed antiruggine.
Consente fluidità dello sterzo ed innesti
morbidi e silenziosi nelle trasmissioni.

Codice	Contenuto	Cartone
• 0707	L. 1	1x12



MARK PASTA NERA SILICONICA

Sigillante siliconico ossimico neutro e tissotropico.
Indicato nella sigillatura della coppa dell'olio dei motori fire.
Aderisce su materiali vinilici, plastica e gomma.
Specifico per motori diesel, trattori e macchine movimento terra.
Prodotto inodore ossimico.
Temperature di resistenza -70°C +300°C.

Codice	Contenuto	Cartone
• 0756	Gr. 95	1x30



MARK PASTA NERA SILICONICA AD ESTRUSIONE

Sigillante siliconico ossimico neutro e tissotropico
Indicato nella sigillatura della coppa dell'olio dei motori fire.
Aderisce su materiali vinilici, plastica e gomma.
Specifico per motori diesel, trattori e macchine movimento terra.
Pratico erogatore ad estrusione con modulatore di uscita e di spessore.
Prodotto inodore ossimico.
Temperature di resistenza -70°C $+300^{\circ}\text{C}$.

Codice	Contenuto	Cartone
•0757	ml. 200	1x6

con
modulatore
di spessore
regolabile
ad uscita



MARK PASTA ROSSA SILICONICA

Sigillante siliconico acetico autolivellante.
Utilizzato per formare guarnizioni plastiche di spessori differenti.
Viene utilizzato per scatole del cambio e differenziale,
coperchi valvole, coppe olio, carters.
Aderisce perfettamente alla superficie
garantendone la tenuta.
Temperature di resistenza -70°C $+270^{\circ}\text{C}$.

Codice	Contenuto	Cartone
•0755	ml. 75	1x30



ERMETICO GUARNIZIONI

Adesivo per il fissaggio delle guarnizioni di carters e motori.
Insolubile agli idrocarburi ed ai fluidi anticongelanti.
Resistente al calore e alla compressione.
Non indurisce, rimane elastico in modo permanente.

Codice	Contenuto	Cartone
•0761	ml. 125	1X24
•0751	ml. 200	1X24



SMERIGLIO VALVOLE Grana fine e grana grossa

Impiegato per la smerigliatura delle valvole dei motori a combustione interna.
Garantisce la tenuta perfetta delle valvole.
La grana fine consente finiture precise.

Codice	Caratteristica	Contenuto	Cartone
•0800	Grana fine	ml. 125	1X12
•0810	Grana grossa	ml. 125	1X12



ASSEMBLAGGIO MARMITTE

Sigilla le giunzioni e ripara i fori nei sistemi di scarico.
Resistente alle alte temperature (fino a 1000°C).
Garantito contro le perdite.

Codice	Contenuto	Cartone
0805	ml. 80	1x30



TURAFALLE RADIATORI LIQUIDO

Elimina le perdite nei sistemi di raffreddamento di auto e camion.

Viene utilizzato nei radiatori che contengono acqua, antigelo o liquido permanente per radiatori.

Previene la formazione di ruggine e corrosione.



Codice	Contenuto	Cartone
0801	ml. 250	1x24

TURAFALLE RADIATORI POLVERE

Azione rapida e permanente.

Da aggiungere direttamente nel radiatore appena si notano perdite di liquido.



Codice	Contenuto	Cartone
0802	gr. 75	1x12

DISINCROSTANTE RADIATORI

Impiegato per la pulizia interna del circuito di raffreddamento.

Lascia uno speciale velo protettivo.

Efficace anche in presenza di antigelo e liquidi permanenti per radiatori.



Codice	Contenuto	Cartone
0803	ml. 250	1x24

TURAFALLE BLOCCO MOTORE

Sigillante per le incrinature nel sistema di raffreddamento del blocco motore.

Elimina le perdite di cilindri, testate e blocco motore.

Resistente alle alte temperature e alle pressioni elevate.



Codice	Contenuto	Cartone
0804	ml. 250	1x12

PULITORE CARBURATORI & VALVOLA EGR

Pulisce in profondità i carburatori e la valvola EGR.
Contribuisce a migliorare la carburazione e a ridurre il consumo di carburante.

Codice	Contenuto	Cartone
• 0962	ml. 500	1x12



LAVAMOTORI

Pulisce rapidamente le parti esterne del motore.
Scioglie sporco, grasso e catrame.
Potente getto spray per raggiungere e pulire i punti più nascosti.

Codice	Contenuto	Cartone
• 0957	ml. 400	1X6



DEGRIPPANTE

Libera le parti bloccate da incrostazioni ed ossidazioni.
Protegge e lubrifica macchine e parti di macchine.
La sua azione idrorepellente elimina l'umidità dai contatti elettrici
Previene la corrosione delle parti trattate.

Codice	Contenuto	Cartone
• 0951	ml. 400	1x24



GRASSO SPRAY

Lubrificante spray ad alta aderenza.
Ideale per lubrificare tutte le parti meccaniche in movimento.
Protegge i metalli dalla corrosione.
Viene utilizzato nel settore automobilistico, in agricoltura, marina, aeronautica e armeria.

Codice	Contenuto	Cartone
• 0958	ml. 400	1x24



POLISH ANTIGRAFFIO

Speciale per vernici normali e metallizzate
Formula a base di silani.
Ridona alla vernice l'aspetto originale e crea una pellicola idrorepellente.
È antigraffio e resistente al lavaggio automatico.

Codice	Contenuto	Cartone
•0872	ml. 250	1X24



TOGLI GRAFFI

Agisce con efficacia su graffi e righe grazie ai suoi micro granuli.
Ridona l'aspetto originale alla vernice.
Elimina piccole macchie di catrame e resina.

Codice	Contenuto	Cartone
•0870	Gr 150	1X24



PASTA ABRASIVA

Pasta abrasiva a media forza.
Adatta per eliminare graffi profondi e residui di catrame.
Indicata per lucidare vernici anche molto opacizzate.

Codice	Contenuto	Cartone
•0880	ml. 150	1x24



CERA PER AUTO

Cera in crema per lucidare le vernici normali e metallizzate.
Ridona alla carrozzeria la lucentezza del colore originale.
Lascia sulla vernice una pellicola protettiva.

Codice	Contenuto	Cartone
•0850	ml. 250	1x12



CERA RAPIDA CON CARNAUBA

Rapido trattamento lucidante per vernici normali e metallizzate.
Arricchito di cera naturale Carnauba per un'efficace difesa dall'azione degli agenti atmosferici.
Ideale per le auto nuove e le moto.

Codice	Contenuto	Cartone
•0845	ml. 400	1x12



PROTETTORE CRUSCOTTO

Lucida e protegge i rivestimenti di cruscotti e sedili in pelle.
Ridona l'aspetto originale a spoiler e paraurti.
Ideale per auto, caravan e imbarcazioni.

Codice	Contenuto	Caratteristica	Cartone
•0973	ml. 400	Con silicone	1X24
•0963	ml. 500	Senza silicone	1x24



BEST GONFIA E RIPARA

Gonfia istantaneamente i pneumatici forati
con o senza camera d'aria.
Non è necessario smontare la ruota.
Idoneo per auto, moto, caravan e rimorchi.

Codice	Contenuto	Cartone
•0959	ml. 300	1x24



PULITORE ARIA CONDIZIONATA

Elimina istantaneamente odori e muffe dai condizionatori.
Assicura una perfetta sanificazione dei sistemi di refrigeramento.
Efficace per tutti i condizionatori di autoveicoli, casa e industria.

Codice	Contenuto	Cartone
•0952	ml. 200	1x24



READ STARTING FLUID

Partenze rapide dei motori a benzina e diesel.
Avviamento rapido a tutte le temperature.
Ideale per macchine, moto, trattori, tosaerba e imbarcazioni.

Codice	Contenuto	Cartone
•0956	ml. 250	1x24



AUTOSHAMPOO con DTA

Shampoo per il lavaggio delle carrozzerie delle auto sia normali che metallizzate.
Formula con DTA per un risultato autoasciugante brillantante.
Prodotto concentrato.

Codice	Contenuto	Cartone
•0851	L 1	1x24
•0861	L 4	1X4
•0881	L 10	Tanica
•0871	L 30	Tanica



NERO GOMME

Lucida e ravviva il colore dei pneumatici e di tutte le parti in gomma.
Restituisce elasticità e qualità alla gomma secca e screpolata, ridona il colore lucido della gomma nuova.

Codice	Contenuto	Cartone
•0854	L 1	1x24
•0864	L 5	1X4
•0874	L 10	Tanica
•0884	L 30	Tanica



CRISTALLI TRIGGER

Pulisce rapidamente tutti i vetri interni ed esterni dell'auto.
Elimina qualsiasi tipo di sporco.
Ottimi risultati su tutte le superfici.

Codice	Contenuto	Cartone
•0942	ml. 500	1x24



PULITORE FORTE TRIGGER

Sgrassatore multiuso per sporco ostinato.
Idoneo per la pulizia di utensili e macchinari.
Prodotto universale per tutte le superfici.

Codice	Contenuto	Cartone
•0773	ml. 500	1X12



NERO GOMME TRIGGER

Lucida e ravviva il colore dei pneumatici e di tutte le parti in gomma.

Applicazione rapida e facile.

Ridona il colore lucido della gomma nuova.

Codice	Contenuto	Cartone
•0844	ml. 500	1X12



DETERGENTE CERCHIONI TRIGGER

Pulisce i cerchioni in lega e acciaio di auto e moto.

Elimina olio, fango e sporcizia presenti sui cerchioni in lega leggera e acciaio.

Da usare anche su copricerchioni in plastica.

Codice	Contenuto	Cartone
•0875	ml. 500	1x12



DETERGENTE PARAURTI TRIGGER

Pulisce a fondo i paraurti e i fascioni dell'auto.

Dona brillantezza a spoiler e specchietti.

Ideale per paraurti colorati.

Codice	Contenuto	Cartone	Pallet
•0876	ml. 500	1x12	52X12



RINNOVA TESSUTI TRIGGER

Deterge e pulisce gli interni in tessuto dell'auto.

Elimina le macchie e la polvere grazie alla sua schiuma attiva.

Ravviva i colori dei tessuti.

Codice	Contenuto	Cartone	Pallet
•0843	ml. 500	1x12	52X12



LICIA PASTA LAVAMANI

Efficace per togliere dalle mani lo sporco più profondo.
Arricchito con sostanze emollienti per proteggere la pelle.
Utilizzabile anche per pulire pavimenti e piastrelle.

Codice	Contenuto	Cartone
• 0901	cc 1000	1x18
• 0911	Kg 4	1X4



MEGA WIPES

Salviette detergenti umidificate con lato abrasivo, pronte all'uso non necessitano di risciacquo, emollienti e lenitive per la pelle con estratto di Aloe Vera, Vitamine Complex A - E - F e Lanolina. Ottimo in caso di situazione in assenza di acqua.

Codice	Contenuto	Caratteristica	Cartone
• 1510	mt 30	100 strappi da 20x30 cm	1X6



VELOX GLASS ml. 50

Liquido speciale detergente per vaschetta tergicristalli.
Pratico formato monodose.
Garantisce un'ottima visibilità per una guida sicura.
Adatto per la vendita nelle aree di servizio, chain store e ricambisti.

Codice	Contenuto	Cartone
• 0913	ml. 50	1X100
• 0934	ml. 50	1X12X36



VELOX GLASS -30°C - ONE SHOT

Liquido speciale per vaschetta tergicristalli.
Elimina ogni tipo di sporco dal parabrezza.
Detergente anticongelante.
Facilita l'azione delle spazzole.

Codice	Contenuto	Cartone
• 0923	ml. 250	1x48
• 0925	ml. 500	1X24



VELOX GLASS ESTATE - ONE SHOT

Liquido speciale detergente per vaschetta tergicristalli.
Rimuove senza fatica moscerini e qualsiasi tipo di insetto.
Pulisce con facilità il parabrezza.

Codice	Contenuto	Cartone	Pallet
•0924	ml. 250	1X48	48X48



VELOX GLASS -30°C

Liquido speciale per vaschetta tergicristalli.
Detergente e anticongelante.
Elimina ogni tipo di sporco dal parabrezza.
Usato puro resiste fino a -30°C ideale per la
protezione invernale del circuito.

Codice	Contenuto	Cartone
•0933	L 1	1X12
•0936	L 10	Tanica
•0937	L 30	Tanica
•0938	L 1000	Cubo



VELOX GLASS -70°C

Liquido speciale per vaschetta tergicristalli.
Detergente e anticongelante.
Elimina ogni tipo di sporco dal parabrezza.
Usato puro resiste fino a -70°C ideale per la
protezione invernale del circuito.

Codice	Contenuto	Cartone
•0931	L 1	1x12



VELOX GLASS 4 Stagioni Professional

Liquido speciale detergente per vaschetta tergicristalli.
Il pratico beccuccio versatore evita sprechi di prodotto.
Pronto all'uso per una pulizia ottimale del parabrezza.

Codice	Contenuto	Cartone
•1930	L 5	1X4

VELOX GLASS -30°C Professional

Liquido speciale detergente per vaschetta tergicristalli.
Il pratico beccuccio versatore evita sprechi di prodotto.
Usato puro resiste fino a -30°C per la protezione invernale
del circuito.

Codice	Contenuto	Cartone
•1910	L 5	1X4





AbelAuto

Depuis 1931



KIT RINNOVA FARI OTTICI

Rinnova e lucida tutti i tipi di fari.
Azione manuale.

Non necessita ulteriori prodotti

art: **AB098500**

PULITORE TESSUTI CON SPAZZOLA

Contiene distruttore di odori
e pulisce profondamente

400ml

art: **AB802611**



RINNOVATORE PLASTICA ESTERNA

Pulisce e protegge e ridona l'aspetto originale
ai rivestimenti di plastica esteriori

300ml

art: **AB050153**

ACONCAGUA Art. 000008500000 - I12429D

Portasci magnetico con serratura

Magnetic ski carrier with key lock

Porte-skis magnétique avec serrure

Magnetischer Skiträger mit Schloß



HIMALAYA Art. 000007800000 - I03422D

Portasci magnetico con serratura

Magnetic ski carrier with key lock

Porte-skis magnétique avec serrure

Magnetischer Skiträger mit Schloß



VIKING Art. 000008700000 - 113430D

Portasci magnetico con serratura
Magnetic ski carrier with key lock
Porte-skis magnétique avec serrure
Magnetischer Skiträger mit Schloß



SHUTTLE Art. 000008300000 - 107426D

Portasci magnetico con serratura
Magnetic ski carrier with key lock
Porte-skis magnétique avec serrure
Magnetischer Skiträger mit Schloß



WHITE BEAR 4

Art. 00003760000

Portasci da tetto in alluminio con serratura



WHITE BEAR 4

Art. 00061600000

Kit rialzi per WHITE BEAR



YELO

Art. ME00011160

Portasci da barre Menabo Yelo per 6 paia di sci o 4 Snowboard



YELO 4NS

Art. ME0001216

Portasci da barre Menabo Yelo per 6 paia di sci o 4 Snowboard



KIT FUORI CAVA YELO E YELO 4NS

Art. ME0001103

Portasci da barre Menabo Yelo
per 6 paia di sci o 4 Snowboard



ICEBERG

Art. ME0000718

Portasci da barre Menabo Yelo
per 6 paia di sci o 4 Snowboard



KIT FUORI CAVA PER ICEBERG

Art. ME0000847

Portasci da barre Menabo Yelo
per 6 paia di sci o 4 Snowboard



Neve

KREMER CATENE NEVE

OMOLOGATE



7-9-12-16 mm.



roberto botteghi

accessori ricambi auto



WEISSENFELS TRAK AUTO



La nuova TRAK Auto. L'originale catena a montaggio frontale per Auto.

- Maglia in acciaio cementato di alta qualità.
- Totale assenza di componenti nella parte interna del pneumatico per un ingombro da 0mm.
- Tecnologia d'avanguardia abbinata a materiali speciali.
- Sistema di regolazione per l'adattamento a molteplici misure di pneumatici.
- Sistema di montaggio brevettato.
- Misure pneumatici compatibili consultabili nella sezione Download.

Facilità di montaggio 110%

Capacità di trazione 110%

Comfort di guida 90%

WEISSENFELS TRAK SUV



La nuova TRAK SUV. L'originale catena a montaggio frontale per SUV.

- Maglia in acciaio cementato di alta qualità.
- Totale assenza di componenti nella parte interna del pneumatico.
- Tecnologia d'avanguardia abbinata a materiali speciali.
- Sistema di regolazione per l'adattamento a molteplici misure di pneumatici.
- Sistema di montaggio brevettato.
- Misure pneumatici compatibili consultabili nella sezione Download.

Facilità di montaggio 110%

Capacità di trazione 90%

Comfort di guida 90%

Neve

POWERX

Le catene da neve facili da montare, per tutte le vetture.



9 mm

EINSATZBEREICH
PKW
V5117



Angaben des
Fahrzeugherstellers beachten!

70

POWER



WEISSSOCK



WSK



Calza da neve in tessuto tecnico.



- Battistrada in tessuto tecnico con filo multibava ad alta tenacità.
- Cordonature in rilievo ad alta capacità di aderenza.
- WeissSock é omologata secondo la ÖNORM 5121 nonché in base alla normativa europea EN 16662-1.

- Rete in speciale tessuto ad alta resistenza.
- Maniglie ad alta visibilità per la centratura e lo smontaggio a cucitura rinforzata.



K-SOCKS

CALZE DA NEVE

SNOW SOCKS



Solo 7 mm di ingombro interno



Montaggio facile e veloce



Guida silenziosa e senza vibrazioni



Adatte solo a veicoli dotati di ABS



Senza maglie o parti in acciaio



Conformi alla normativa europea EN 16662-1
Compatibili con i dispositivi ABS.
Guida silenziosa e senza vibrazioni.



ID# 0288

zt:

Dipl.-Ing. Dr. Moschik ZT GmbH
Device tested and certified
according EN 16662-1
Reg.Nr: 288-22986



TRANSPORT T

weissentfels
PROFESSIONAL
 CATENE DA NEVE SNOW CHAINS



Gruppo 145

Codice articolo: **PALT0025**

Dimensione pneumatici	R	mm
13/75	R 22.5	6,5
315/80	R 22.5	6,5
385/60	R 22.5	6,5

Gruppo 1430

Codice articolo: **PALT0023**

Dimensione pneumatici	R	mm
12/80	R 22.5	6,5
295/75	R 22.5	6,5
295/80	R 22.5	6,5
315/70	R 22.5	6,5
275/80	R 24.5	6,5
285/75	R 24.5	6,5

Imballo:
1/2 paio di catene in
master di cartone.

Consigliata per camion e autobus	Capacità di trazione	Comfort di guida	Resistenza all'usura
	7 8 9 10	7 8 9 10	7 8 9 10



Camion - Autobus | weissenfels

SETTORI



Imballo:

6 SETTORI per Sacco

Codice articolo	Gruppo	Ø mm	
99PS2500BINW1	B	7	
99PS2500CINW1	C	7	
99PS2500DINW1	D	7	

Consigliati per camion ed autobus	Capacità di trazione	Comfort di guida	Resistenza all'usura
	7 8 9 10	7 8 9 10	7 8 9 10

Montaggio:







ROBERTO
BOTTEGHI

accessori auto e carrozzeria

ROBERTO BOTTEGHI & C. SAS
Via dei Condotti Vecchi, 8 - Livorno
www.robortobotteghisas.it
www.botteghicarrozzeria.it