

TAB. 1

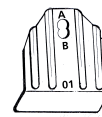
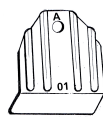

CASA AUTO	MODELLO	PORTE	ANNO
FORD	Kuga II	5	12→
VOLKSWAGEN	Polo V (6R)	3	10→14
VOLKSWAGEN	Polo V (6R)	3	14→17

M1	M2
3,4	10,1
13,3	11,5
13,3	11,5

G1	F1	G2	F2
17	1 foro A	06	B
17	1 foro A	06	B
17	1 foro A	06	B

T1	T2
15	55
49	X
49	X

X = predisposizione originale



1

Tab. 1:
M1
M2

4 x

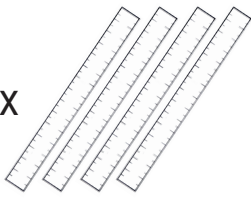

2 x M1

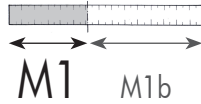

2 x M2

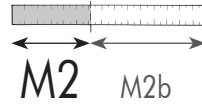

Tagliare i 4 metri in dotazione alla misura M1 ed M2 riportate in tabella

2

2 x



M1 - M2

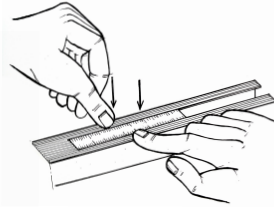
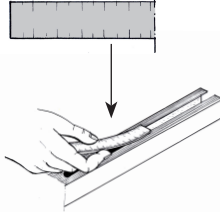

Inserire il metro tagliato in misura M1 nelle 2 cave della barra anteriore, portandolo fine a fine corsa.
Ripetere l'operazione per la barra posteriore con i metri tagliati in misura M2.

3

4 x

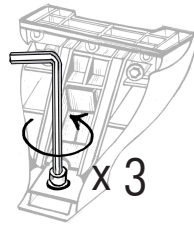
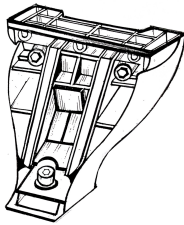

x 3

Prendere i 4 piedi dalla scatola, allentare la vite affinché i piedi possano entrare nella cava.
Prendere il primo piede ed inserirlo in cava facendo **ATTENZIONE** a non sormontare il metro precedentemente inserito, stringere con forza la vite del piede.
Ripetere l'operazione per tutti i 4 piedi ciascuno in una cava.

5 Nm

K1

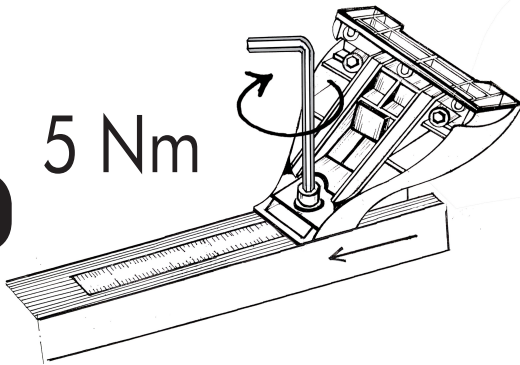

5 Nm

K1pro

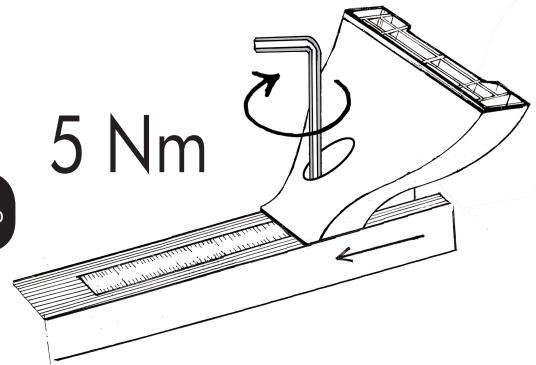

4

M1b - M2b



Inserire l'avanzo del metro tagliato (M1b per la barra anteriore ed M2b per la barra posteriore) per coprire la cava scoperta.

Ripetere l'operazione per tutte e 2 le barre.
Inserire, infine, i 4 tappi come indicato in figura.

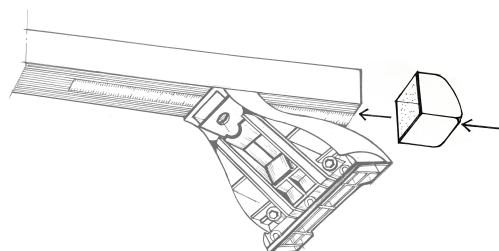
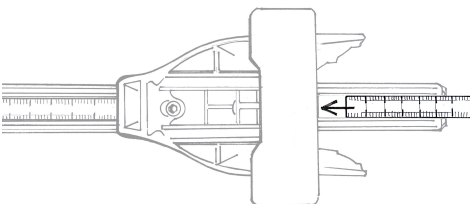

5



Tab. 1:
G1-F1
G2-F2

4 x

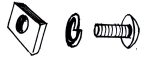
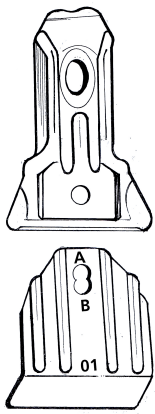

8x14

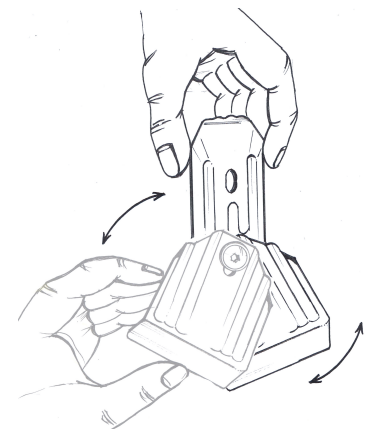
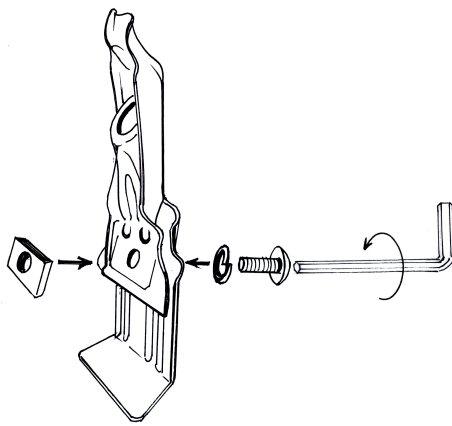

Assemblare le 4 GANASCINE come mostrato in figura, facendo **ATTENZIONE** a rispettare le misure riportate in tabella. Lasciare la parte inferiore della ganascina lasca.

6

8x50

4 x

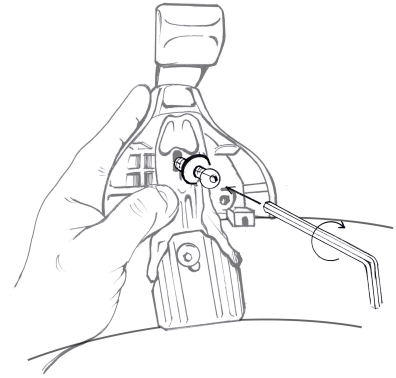
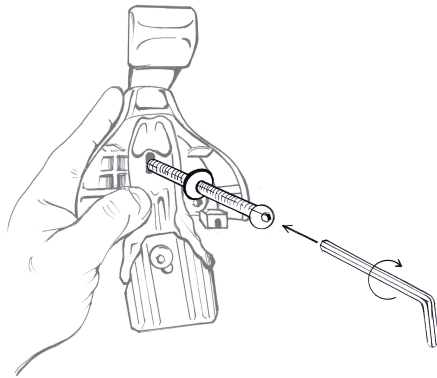

Posizionare la barra anteriore e la barra posteriore sul tetto dell'autovettura. Fissare le ganascine ai 4 piedi facendo **ATTENZIONE** a non stringere completamente la vite.

7



Tab. 1:
T1
T2

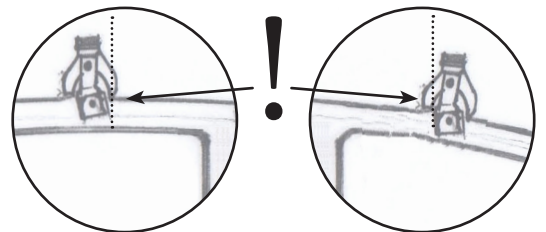
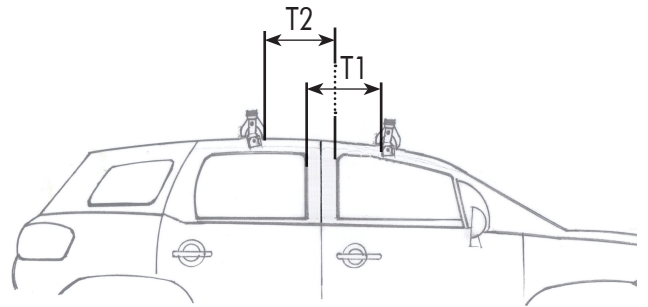
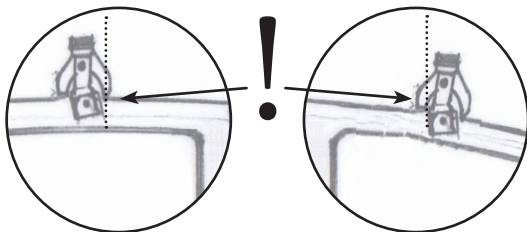
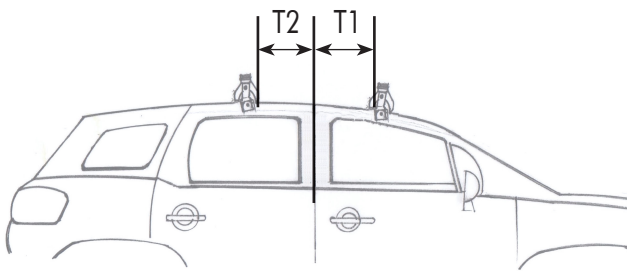

8

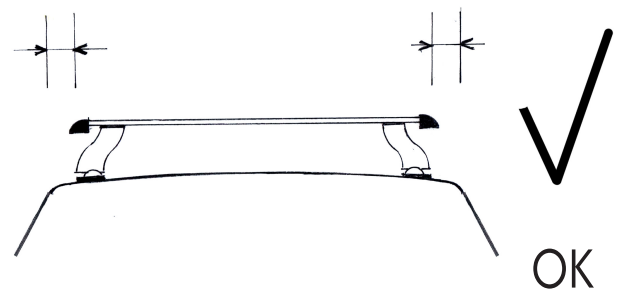
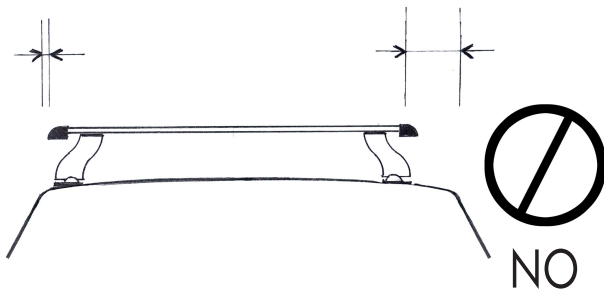

9

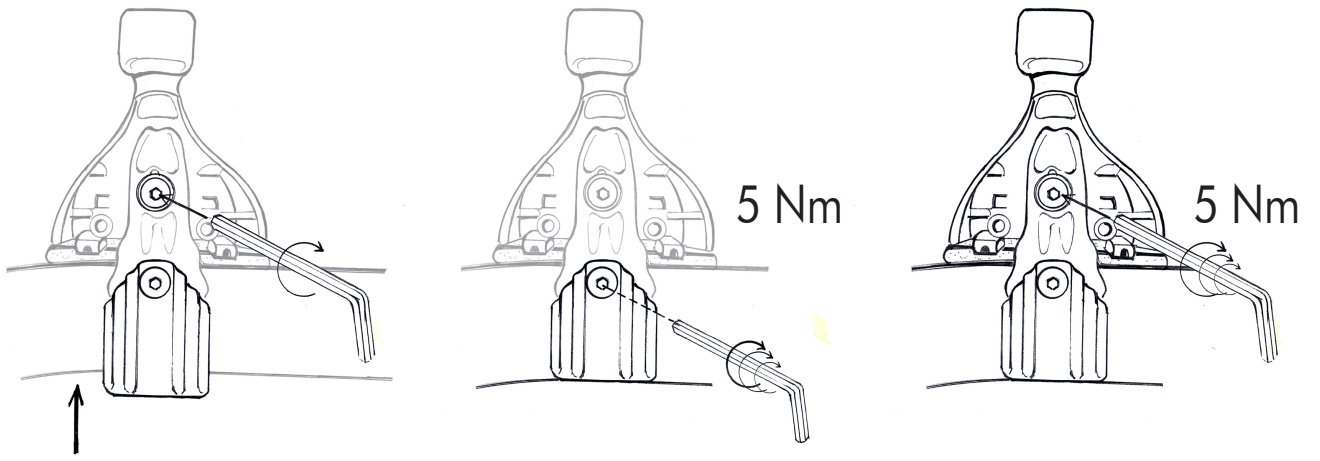

Stringere la vite superiore fino ad accompagnare la parte inferiore della ganascina al tetto. Stringere con forza la vite inferiore. Stringere con forza la vite superiore facendo **ATTENZIONE** a non spostare la centratura delle barre. Per ottenere il risultato corretto stringere le viti alternando il lato destro al lato sinistro in maniera uniforme.

10a



K1



x 4

10b



K1pro





x 4

MAX
55 kg

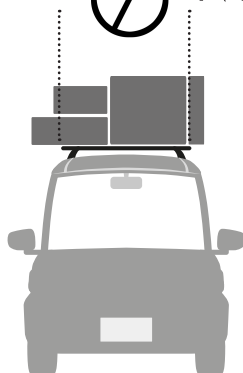

 NO



 OK

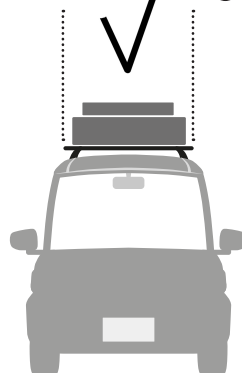

 NO

