

**TAB. 1**

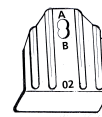
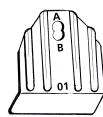

CASA AUTO	MODELLO	PORTE	ANNO
FIAT	Bravo	3	95→01
FORD	Fiesta V	3	02→08
HONDA	HR-V I (No railing)	3	99→05

M1	M2
10,0	8,6
5,9	5,5
10,1	8,0

G1	F1	G2	F2
01	A	02	B
01	B	02	A
01	A	02	B

T1	T2
X	X
48	28
29	49

X = predisposizione originale



X =

1

 Tab. 1:  
M1  
M2

4 x

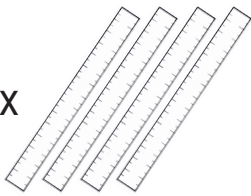

2 x M1

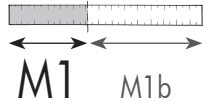

2 x M2

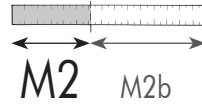

Tagliare i 4 metri in dotazione alla misura M1 ed M2 riportate in tabella

2

2 x



M1 - M2

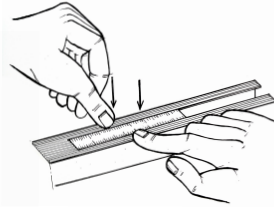
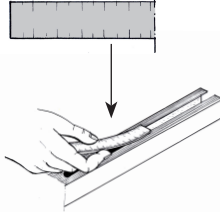

Inserire il metro tagliato in misura M1 nelle 2 cave della barra anteriore, portandolo fine a fine corsa.  
Ripetere l'operazione per la barra posteriore con i metri tagliati in misura M2.

3

4 x

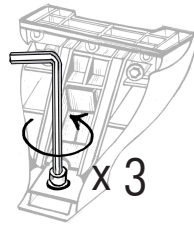
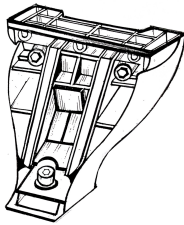

Prendere i 4 piedi dalla scatola, allentare la vite affinché i piedi possano entrare nella cava.  
Prendere il primo piede ed inserirlo in cava facendo **ATTENZIONE** a non sormontare il metro precedentemente inserito, stringere con forza la vite del piede.  
Ripetere l'operazione per tutti i 4 piedi ciascuno in una cava.

5 Nm

K1

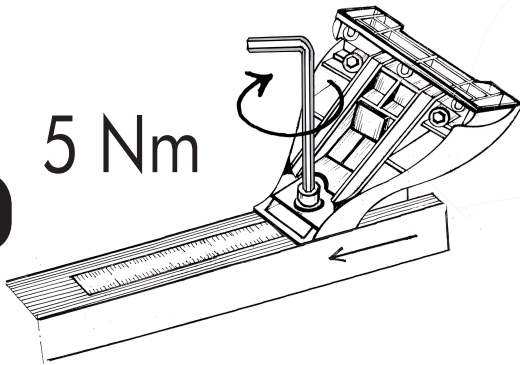

5 Nm

K1pro

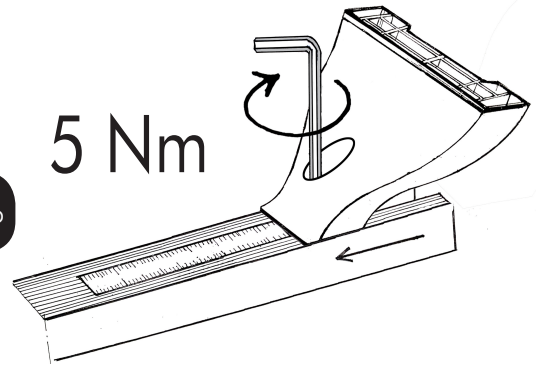

4

M1b - M2b



Inserire l'avanzo del metro tagliato (M1b per la barra anteriore ed M2b per la barra posteriore) per coprire la cava scoperta.

Ripetere l'operazione per tutte e 2 le barre.  
Inserire, infine, i 4 tappi come indicato in figura.

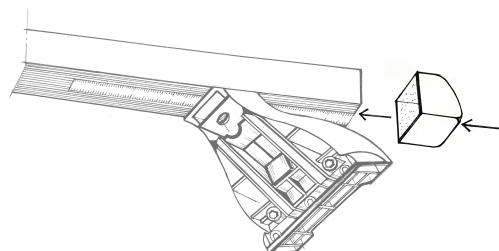
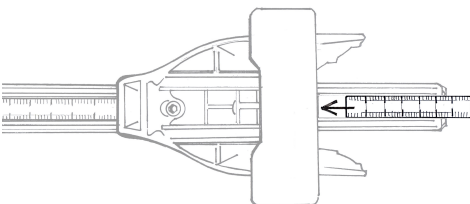

5

 Tab. 1:  
G1-F1  
G2-F2

4 x

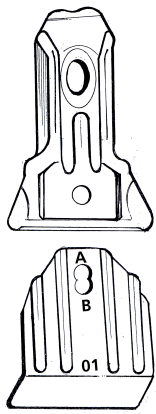

8x14

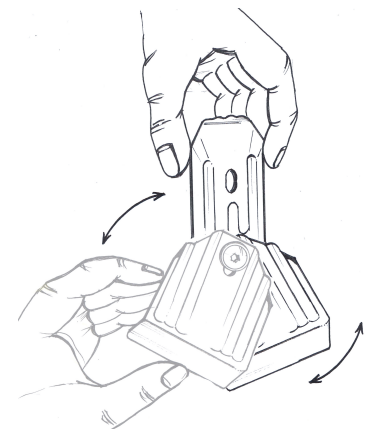
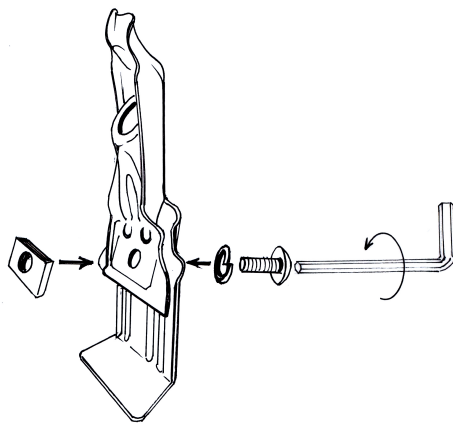

Assemblare le 4 GANASCINE come mostrato in figura, facendo **ATTENZIONE** a rispettare le misure riportate in tabella. Lasciare la parte inferiore della ganascina lasca.

6

8x50

4 x

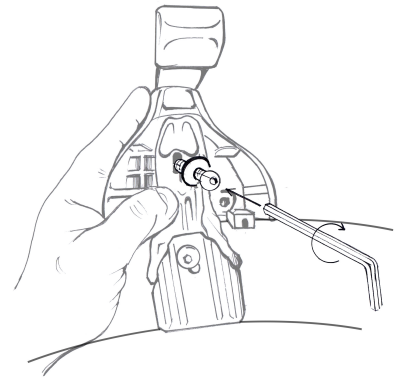
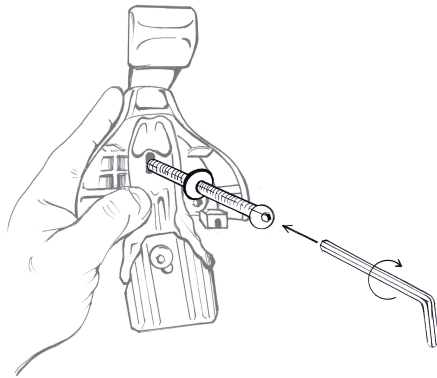

Posizionare la barra anteriore e la barra posteriore sul tetto dell'autovettura. Fissare le ganascine ai 4 piedi facendo **ATTENZIONE** a non stringere completamente la vite.

7

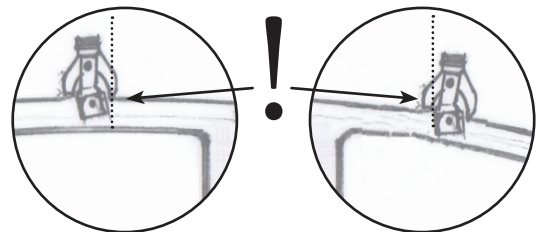
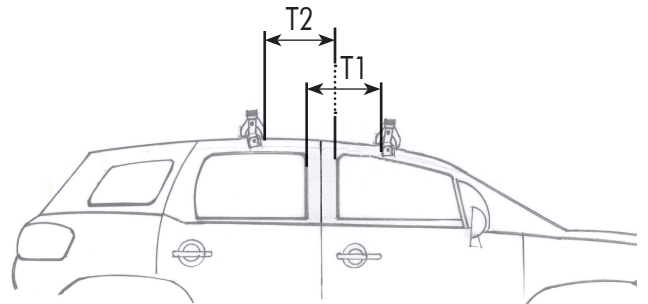
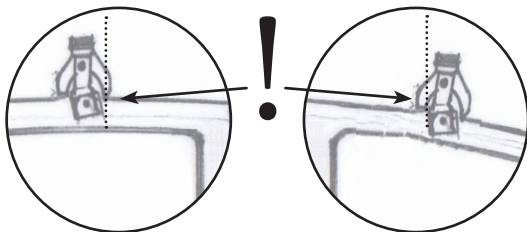
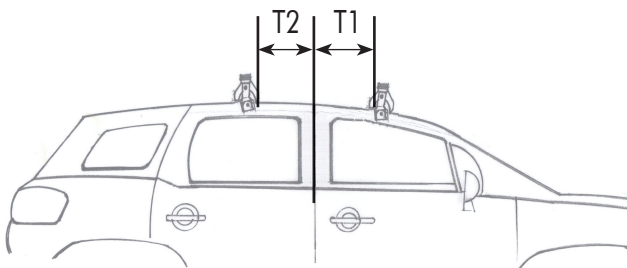
 Tab. 1:  
T1  
T2

8

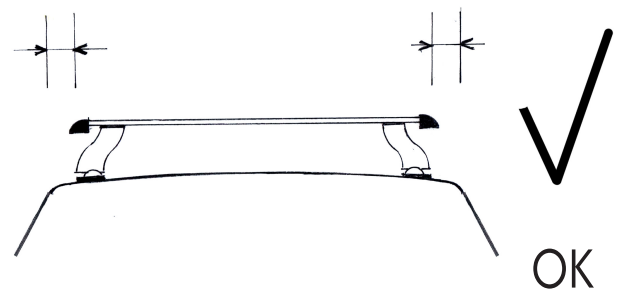
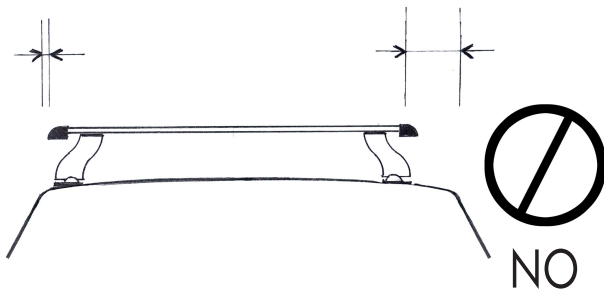

9

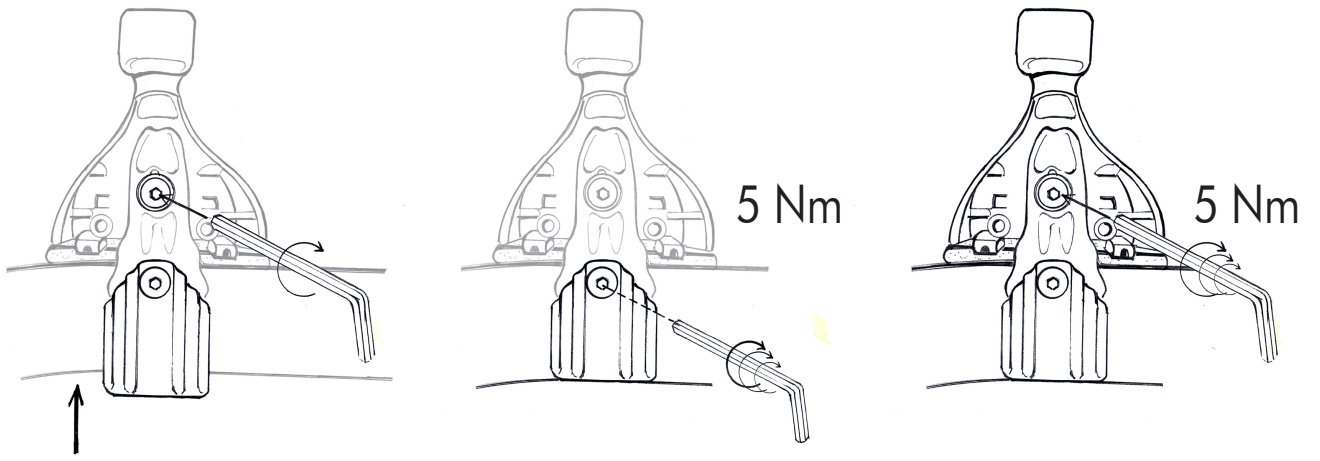

Stringere la vite superiore fino ad accompagnare la parte inferiore della ganascina al tetto. Stringere con forza la vite inferiore. Stringere con forza la vite superiore facendo **ATTENZIONE** a non spostare la centratura delle barre. Per ottenere il risultato corretto stringere le viti alternando il lato destro al lato sinistro in maniera uniforme.

10a



K1



10b



K1pro



MAX  
55 kg



NO

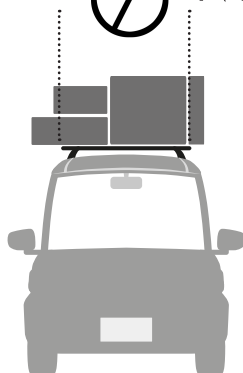

OK

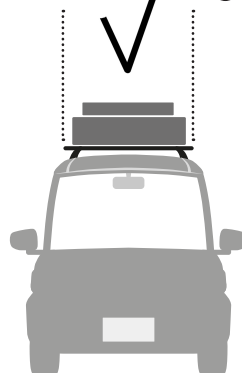

NO

